

NETGEAR®

N150 2-Port Wireless Router WNR612v3 User Manual



350 East Plumeria Drive
San Jose, CA 95134
USA

August 2012
202-11019-01
v1.0

©2012 NETGEAR, Inc. All rights reserved.

No part of this publication may be reproduced, transmitted, transcribed, stored in a retrieval system, or translated into any language in any form or by any means without the written permission of NETGEAR, Inc.

Technical Support

Thank you for choosing NETGEAR. To register your product, get the latest product updates, or get support online, visit us at <http://support.netgear.com>.

Phone (US & Canada only): 1-888-NETGEAR

Phone (Other Countries): See Support information card.

Trademarks

NETGEAR, the NETGEAR logo, and Connect with Innovation are trademarks and/or registered trademarks of NETGEAR, Inc. and/or its subsidiaries in the United States and/or other countries. Information is subject to change without notice. Other brand and product names are registered trademarks or trademarks of their respective holders. © 2011 NETGEAR, Inc. All rights reserved.

Statement of Conditions

To improve internal design, operational function, and/or reliability, NETGEAR reserves the right to make changes to the products described in this document without notice. NETGEAR does not assume any liability that may occur due to the use, or application of, the product(s) or circuit layout(s) described herein.

Contents

Chapter 1 Hardware Setup

Unpack Your Router	7
Position Your Router	7
Hardware Features	8
Front Panel	8
Back Panel	9
Label	10

Chapter 2 Getting Started with NETGEAR genie

Router Setup Preparation	12
Use Standard TCP/IP Properties for DHCP	12
Gather ISP Information	12
Wireless Devices and Security Settings	12
Types of Logins and Access	12
NETGEAR genie Setup	13
Use NETGEAR genie After Installation	14
Upgrade Router Firmware	14
Router Dashboard (Basic Home Screen)	15
Join Your Wireless Network	16
NETGEAR genie App and Mobile genie App	16

Chapter 3 NETGEAR genie Basic Settings

Basic Home Screen	19
Internet Settings	19
Internet Settings Screen Fields	20
Attached Devices	21
Parental Controls	22
Basic Wireless Settings	24
Wireless Settings Screen Fields	25
Change WPA Security Option and Passphrase	26
Guest Networks	27
Guest Network Wireless Security Options	28
FastLane	29

Chapter 4 NETGEAR genie Advanced Home

NETGEAR genie Advanced Screen	31
Setup Wizard	31
WPS Wizard	32

Setup Menu	33
WAN Setup	33
Default DMZ Server	35
Change the MTU Size	35
LAN Setup	37
LAN Setup Screen Settings	38
Use the Router as a DHCP Server	38
Address Reservation	39
Quality of Service (QoS) Setup	40

Chapter 5 Security

Keyword Blocking of HTTP Traffic	45
Block Services (Port Filtering)	46
Schedule Blocking	48
Security Event Email Notifications	49

Chapter 6 Administration

Upgrade the Firmware	51
View Router Status	52
Router Information	52
Internet Provider (WAN) Setup	52
Statistics	53
Connection Status	54
Wireless AP	55
View Logs of Web Access or Attempted Web Access	56
Manage the Configuration File	57
Back Up Settings	57
Restore Configuration Settings	57
Erase	58
Set Password	58

Chapter 7 Advanced Settings

Advanced Wireless Settings	60
Restrict Wireless Access by MAC Address	61
Wireless Repeating Function (WDS)	62
Wireless Repeating Function	63
Set Up the Base Station	64
Set Up a Repeater Unit	65
Port Forwarding and Triggering	65
Remote Computer Access Basics	65
Port Triggering to Open Incoming Ports	67
Port Forwarding to Permit External Host Communications	68
How Port Forwarding Differs from Port Triggering	69
Set Up Port Forwarding to Local Servers	69
Add a Custom Service	70
Edit or Delete a Port Forwarding Entry	71

Set Up Port Triggering	71
Dynamic DNS	73
Static Routes	74
Remote Management	76
Universal Plug and Play	77
Traffic Meter	78

Chapter 8 Troubleshooting

Quick Tips	81
Sequence to Restart Your Network	81
Check Ethernet Cable Connections	81
Wireless Settings	81
Network Settings	81
Troubleshooting with the LEDs	82
Power/Test LED Is Off or Blinking	82
Internet or Ethernet Port LEDs Are Off	82
Wireless LED Is Off	83
Cannot Log In to the Router	83
Cannot Access the Internet	83
Troubleshooting PPPoE	85
Troubleshooting Internet Browsing	85
Changes Not Saved	86
Wireless Connectivity	86
Wireless Signal Strength	86
Restore the Factory Settings and Password	87
Troubleshoot Your Network Using the Ping Utility	87
Test the LAN Path to Your Router	87
Test the Path from Your Computer to a Remote Device	88

Appendix A Supplemental Information

Factory Settings	89
Technical Specifications	90

Appendix B Notification of Compliance

Index

Hardware Setup

1

Getting to know your router

If you already set up your N150 2-Port Wireless Router, you can skip this chapter. If you have not done that yet, this chapter covers the hardware setup. *Chapter 3, NETGEAR genie Basic Settings*, explains how to set up your Internet connection.

This chapter contains the following sections:

- *Unpack Your Router*
- *Position Your Router*
- *Hardware Features*

The NETGEAR genie® app provides easy installation from an iPad, tablet, computer, or smartphone. It includes a personal dashboard that lets you to manage, monitor, and repair your home network. NETGEAR customers can download the app at www.netgear.com/genie or from the Google Play or App Store.

For more information about the topics covered in this manual, visit the Support website at <http://support.netgear.com>.

Unpack Your Router

Open the box and remove the router, cables, and installation guide.



Figure 1. Check the package contents

Your box contains the following items:

- N150 2-Port Wireless Router WNR612v3
- AC power adapter (plug varies by region)
- Category 5 (Cat 5) Ethernet cable
- Installation guide with cabling and router setup instructions

If any parts are incorrect, missing, or damaged, contact your NETGEAR dealer. Keep the carton and original packing materials, in case you need to return the product for repair.

Position Your Router

The router lets you access your network from virtually anywhere within the operating range of your wireless network. However, the operating distance or range of your wireless connection can vary significantly depending on the physical placement of your router. For example, the thickness and number of walls the wireless signal passes through can limit the range. For best results, place your router:

- Near the center of the area where your computers and other devices operate and preferably within line of sight to your wireless devices.
- So it is accessible to an AC power outlet and near Ethernet cables for wired computers.

- In an elevated location such as a high shelf, keeping the number of walls and ceilings between the router and your other devices to a minimum.
- Away from electrical devices that are potential sources of interference. Equipment that might cause interference includes ceiling fans, home security systems, microwaves, PCs, the base of a cordless phone, or 2.4-GHz cordless phone.
- Away from any large metal surfaces, such as a solid metal door or aluminum studs. Large expanses of other materials such as glass, insulated walls, fish tanks, mirrors, brick, and concrete can also affect your wireless signal.

When you use multiple access points, it is better if adjacent access points use different radio frequency channels to reduce interference. The recommended channel spacing between adjacent access points is 5 channels (for example, use Channels 1 and 6, or 6 and 11).

Hardware Features

Before you cable your router, take a moment to become familiar with the front, side, and back panels and the label. Pay particular attention to the LEDs on the front panel.





Front Panel

The router front panel has the status LEDs and icons shown in the following figure.



Figure 2. Router front view

Table 1. Front panel LED descriptions

LED	Description
Power/ Check 	<ul style="list-style-type: none"> • Solid green. Power is supplied to the router. • Blinking green. The router is starting up. • Off. Power is not supplied to the router.
Wireless 	<ul style="list-style-type: none"> • Blinking green. Data is being transmitted or received over the wireless link. • Off. The wireless radio is turned off.
Internet 	<ul style="list-style-type: none"> • Solid green. The Internet connection is established. • Blinking green. There is traffic on the Internet port. • Off. No Internet connection.
Ethernet (1, 2) 	<ul style="list-style-type: none"> • Solid green. The LAN port has detected an Ethernet link with a device such as a computer. • Blinking green. Data is being transmitted or received. • Off. No link is detected on this port.

Back Panel

The back panel has the connections shown in the following figure.

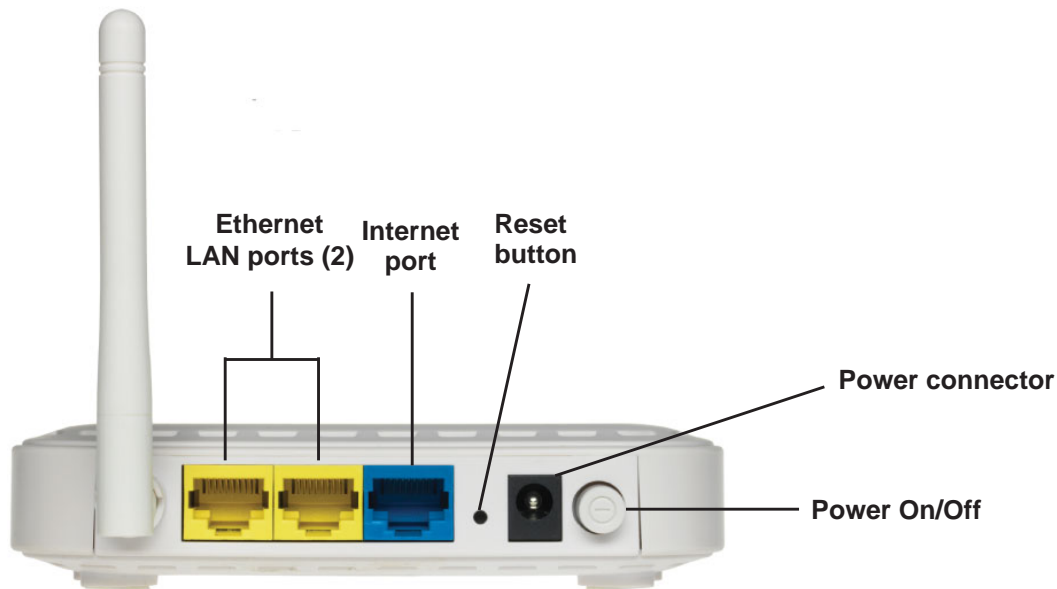

Figure 3. Router, rear view

See [Factory Settings](#) on page 89 for information about restoring factory settings.

Label

The label on the bottom of the router shows the preset WiFi network name and password, login information, MAC address, and serial number.

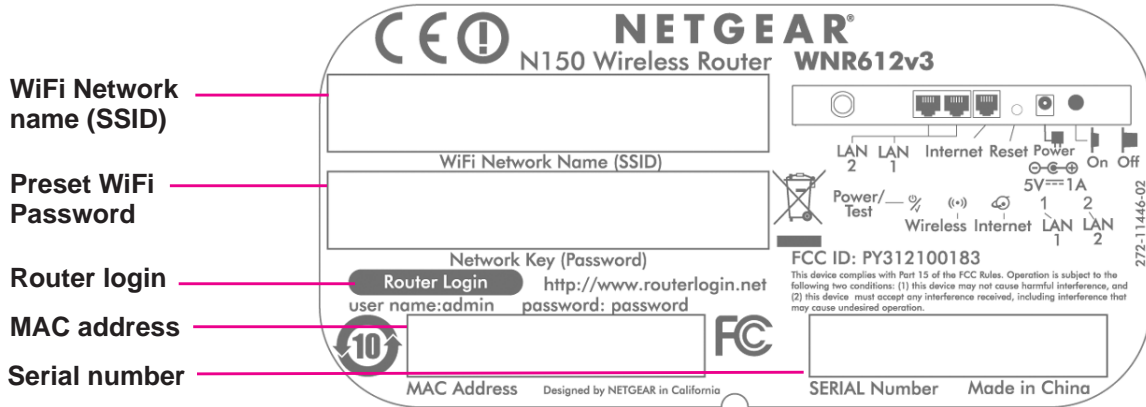

Figure 4. The label shows unique information about your router

2 Getting Started with NETGEAR genie

2

Connecting to the router

This chapter explains how to use NETGEAR genie to set up your router after you complete cabling as described in the installation guide and in the previous chapter.

This chapter contains the following sections:

- *Router Setup Preparation*
- *Types of Logins and Access*
- *NETGEAR genie Setup*
- *Use NETGEAR genie After Installation*
- *Upgrade Router Firmware*
- *Router Dashboard (Basic Home Screen)*
- *Join Your Wireless Network*
- *NETGEAR genie App and Mobile genie App*

Router Setup Preparation

You can set up your router with the NETGEAR genie automatically, or you can use the genie menus and screens to set up your router manually. Before you start the setup process, get your ISP information and make sure the computers and devices in the network have the settings described here.

Use Standard TCP/IP Properties for DHCP

If you set up your computer to use a static IP address, you need to change the settings so that it uses Dynamic Host Configuration Protocol (DHCP).

Gather ISP Information

If you have DSL broadband service, you might need the following information to set up your router and to check that your Internet configuration is correct. When your Internet service starts, your Internet service provider (ISP) typically gives you all the information needed to connect to the Internet. If you cannot locate this information, ask your ISP to provide it. When your Internet connection is working, you no longer need to launch the ISP's login program on your computer to access the Internet. When you start an Internet application, your router automatically logs you in. Make sure that you have the following information:

- The ISP configuration information for your DSL account
- ISP login name and password
- Fixed or static IP address settings (special deployment by ISP; this is rare)

Wireless Devices and Security Settings

Make sure that the wireless device or computer that you are using supports WPA or WPA2 wireless security, which is the wireless security that the router uses.

Types of Logins and Access

There are separate types of logins that have different purposes. It is important that you understand the difference so that you know which login to use when.

- **Router login** logs you in to the router interface from NETGEAR genie. See [Use NETGEAR genie After Installation](#) on page 14 for details about this login.
- **ISP login** logs you in to your Internet service. Your service provider has provided you with this login information in a letter or some other way. If you cannot find this login information, contact your service provider.
- **Wireless network key or password.** Your router is preset with a unique wireless network name (SSID) and password for wireless access. This information is on the label on the bottom of your router.

NETGEAR genie Setup

NETGEAR genie runs on any device with a web browser. Installation and basic setup takes about 15 minutes to complete.

➤ **To use NETGEAR genie to set up your router:**

1. Turn the router on by pressing the **On/Off** button.
2. Make sure that your computer or wireless device is connected to the router with an Ethernet cable (wired) or wirelessly with the preset security settings listed on the bottom label.
3. Launch your Internet browser.
 - The first time you set up the Internet connection for your router, the browser goes to <http://www.routerlogin.net> and the NETGEAR genie screen displays.
 - If you already used the NETGEAR genie, type **<http://www.routerlogin.net>** in the address field for your browser to display the NETGEAR genie screen. See *Use NETGEAR genie After Installation* on page 14.
4. Follow the onscreen instructions to complete NETGEAR genie setup. NETGEAR genie guides you through connecting the router to the Internet.

If the browser cannot display the web page:

- Make sure that the computer is connected to one of the four LAN Ethernet ports or wirelessly to the router.
- Make sure that the router has full power, and that its wireless LED is lit.
- Close and reopen the browser to make sure that the browser does not cache the previous page.
- Browse to **<http://www.routerlogin.net>**.
- If the computer is set to a static or fixed IP address (this is uncommon), change it to obtain an IP address automatically from the router.

If the router does not connect to the Internet:

1. Review your settings to be sure that you have selected the correct options and typed everything correctly.
2. Contact your ISP to verify that you have the correct configuration information.
3. Read *Chapter 8, Troubleshooting*. If problems persist, register your NETGEAR product and contact NETGEAR technical support.

Use NETGEAR genie After Installation

When you first set up your router, NETGEAR genie automatically starts when you launch an Internet browser on a computer that is connected to the router. You can use NETGEAR genie again if you want to view or change settings for the router.

1. Launch your browser from a computer or wireless device that is connected to the router.
2. Type **http://www.routerlogin.net** or **http://www.routerlogin.com**.

The login window displays:



The screenshot shows a login dialog box with a light beige background. It has two input fields: 'User name:' with a dropdown menu showing 'admin' and a blue arrow, and 'Password:' with a masked field of seven asterisks. Below the password field is a checkbox labeled 'Remember my password' which is currently unchecked. At the bottom of the dialog are two buttons: 'OK' and 'Cancel'.

3. Enter **admin** for the router user name and **password** for the router password, both in lowercase letters.

Note: The router user name and password are different from the user name and password for logging in to your Internet connection. See [Types of Logins and Access](#) on page 12 for more information.

Upgrade Router Firmware

When you set up your router and are connected to the Internet, the router automatically checks for you to see if newer firmware is available. If it is, a message is displayed on the top of the screen. See [Upgrade the Firmware](#) on page 51 for more information about upgrading firmware.

Click the message when it shows up and click **Yes** to upgrade the router with the latest firmware. After the upgrade, the router restarts.



CAUTION:

Do not try to go online, turn off the router, shut down the computer, or do anything else to the router until the router finishes restarting and the Power LED has stopped blinking for several seconds.

Router Dashboard (Basic Home Screen)

The router Basic Home screen has a dashboard that lets you see the status of your Internet connection and network at a glance. You can click any of the five sections of the dashboard to view more detailed information. The left column has the menus, and at the top, there is an Advanced tab that you can use to access additional menus and screens.

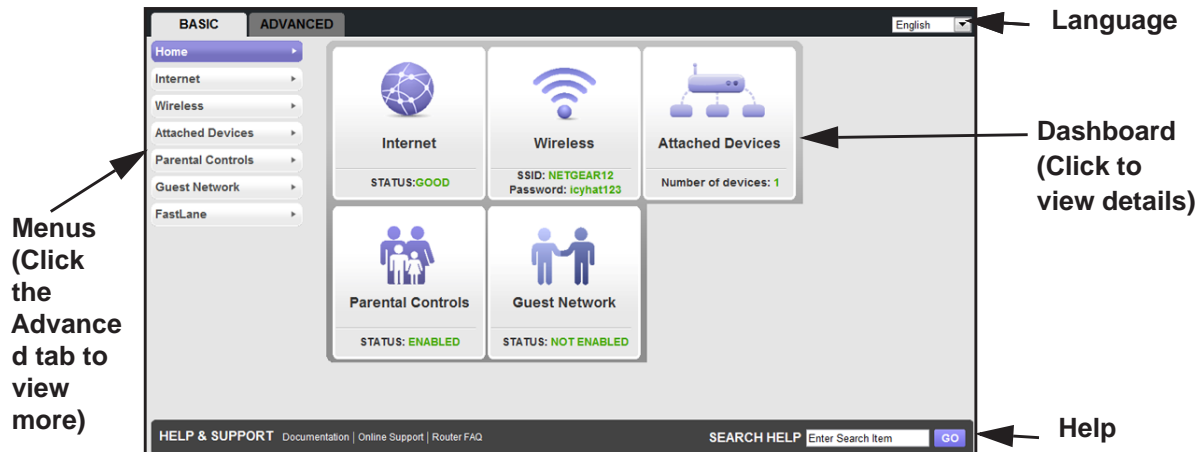

Figure 5. Router Basic Home screen with dashboard, language, and online help

- **Home.** This dashboard screen displays when you log in to the router.
- **Internet.** Set, update, and check the ISP settings of your router.
- **Wireless.** View or change the wireless settings for your router.
- **Attached Devices.** View the devices connected to your network.
- **Parental Controls.** Download and set up parental controls to prevent objectionable content from reaching your computers.
- **Guest Network.** Set up a guest network to allow visitors to use your router's Internet connection.
- **Advanced tab.** Set the router up for unique situations such as when remote access by IP or by domain name from the Internet is needed. See [Chapter 7, Advanced Settings](#). You need a solid understanding of networking protocols to use this tab.
- **Help & Support.** Go to the NETGEAR support site to get information, help, and product documentation. These links work once you have an Internet connection.

Join Your Wireless Network

Choose either the manual or the WPS method to join your wireless network. See *Chapter 4, WPS Wizard* for instructions for how to use WPS to join the network.

With the manual method, choose the network that you want and type its password to connect.

➤ **To connect manually:**

1. On your computer or wireless device, open the software that manages your wireless connections. This software scans for all wireless networks in your area.
2. Look for your network and select it.

The unique WiFi network name (SSID) and password is on the router label. If you changed these settings, then look for the network name that you used.

3. Enter the router password and click **Connect**.

NETGEAR genie App and Mobile genie App

The genie app is the easy dashboard for managing, monitoring, and repairing your home network. See the NETGEAR genie App User Manual for details about the genie apps.



The genie app can help you with the following:

- Automatically repair common wireless network problems.
- Have easy access to router features like Live Parental Controls, guest access, Internet traffic meter, speed test, and more.

The genie mobile app works on your iPhone, iPad, or Android phone:

Phone status

Log in to the router

Search NETGEAR support

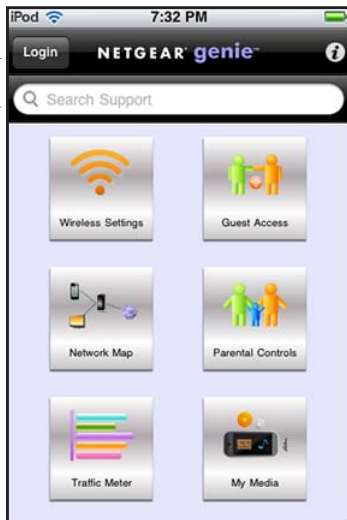

Information about genie mobile app and the connected router

3 NETGEAR genie Basic Settings

3

Your Internet connection and network

This chapter contains the following sections:

- *Basic Home Screen*
- *Internet Settings*
- *Attached Devices*
- *Parental Controls*
- *Basic Wireless Settings*
- *Guest Networks*
- *FastLane*

Basic Home Screen

The genie Basic Home screen is shown in the following figure:

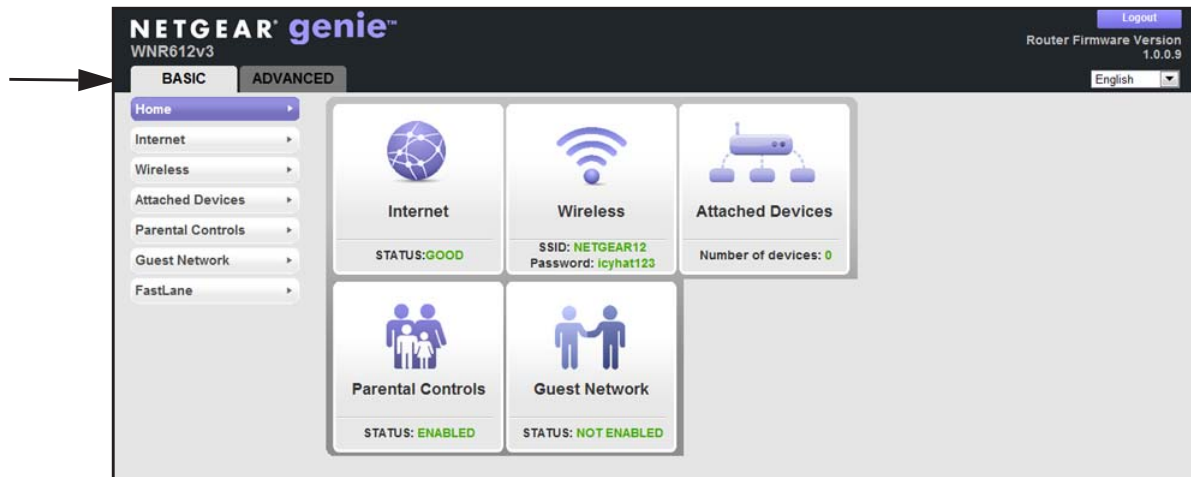

Internet Settings

The Internet Settings screen is where you view or change ISP information.

➤ **To change the Internet settings:**

1. From the Home screen, select **Internet**. The following screen displays:

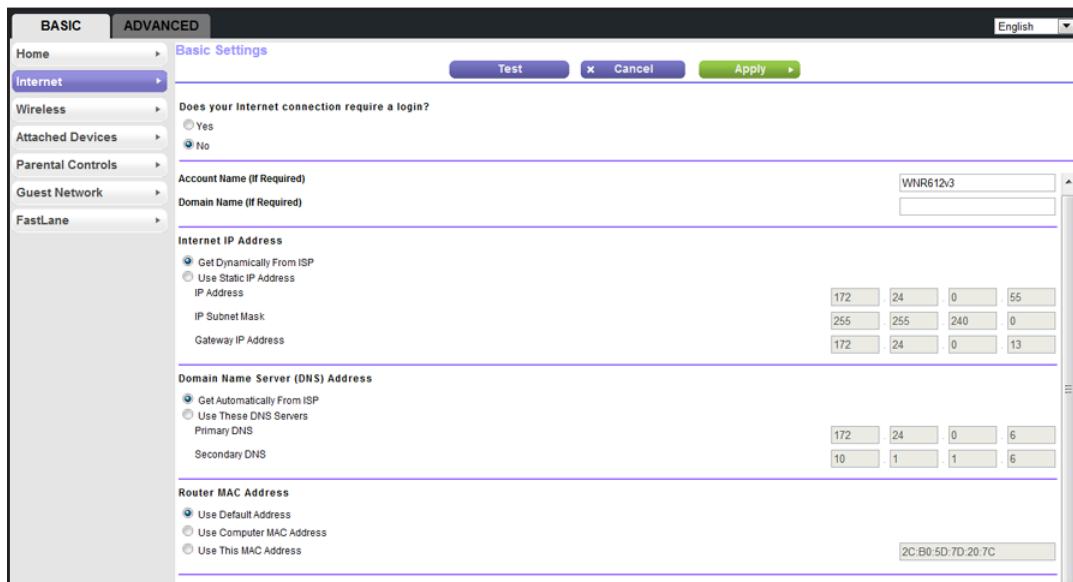

The fields that display in the Internet Setup screen depend on whether your Internet connection requires a login.

- **Yes.** Select the encapsulation method and enter the login name. If you want to change the login time-out, enter a new value in minutes.
 - **No.** Enter the account and domain names, only if your ISP requires them.
2. Enter the settings for the IP address and DNS server. The default settings usually work fine. If you have problems with your connection, check the ISP settings.
 3. Click **Apply** to save your settings.
 4. Click **Test** to test your Internet connection. If the NETGEAR website does not display within 1 minute, see [Chapter 8, Troubleshooting](#).

Internet Settings Screen Fields

The following descriptions explain all of the possible fields in the Internet Setup screen. The fields that display in this screen depend on whether an ISP login is required.

Does Your ISP Require a Login? Answer either yes or no.

These fields display when no login is required:

- **Account Name (if required).** Enter the account name that your ISP provided. This might also be called the host name.
- **Domain Name (if required).** Enter the domain name that your ISP provided.

These fields display when your ISP requires a login:

- **Internet Service Provider Encapsulation.** Choose an ISP types. PPPoE, PPTP, or L2TP.
- **Login.** The login name provided by your ISP. This is often an email address.
- **Password.** The password that you use to log in to your ISP.
- **Idle Timeout (In minutes).** If you want to change the login timeout, enter a new value in minutes. This determines how long the router keeps the Internet connection active after there is no Internet activity from the LAN. A value of 0 (zero) means never log out.

Internet IP Address.

- **Get Dynamically from ISP.** Your ISP uses DHCP to assign your IP address. Your ISP automatically assigns these addresses.
- **Use Static IP Address.** Enter the IP address, IP subnet mask, and the gateway IP address that your ISP assigned. The gateway is the ISP's router to which your router will connect.

Domain Name Server (DNS) Address. The DNS server is used to look up site addresses based on their names.

- **Get Automatically from ISP.** Your ISP uses DHCP to assign your DNS servers. Your ISP automatically assigns this address.

- **Use These DNS Servers.** If you know that your ISP requires specific servers, select this option. Enter the IP address of your ISP's primary DNS server. If a secondary DNS server address is available, enter it also.

Router MAC Address. The Ethernet MAC address that the router uses on its Internet port. Some ISPs register the MAC address of the network interface card in your computer when your account is first opened. They accept traffic only from the MAC address of that computer. This feature allows your router to use your computer's MAC address (this is also called cloning).

- **Use Default Address.** Use the default MAC address.
- **Use Computer MAC Address.** The router captures and uses the MAC address of the computer that you are now using. You have to use the one computer that is allowed by the ISP.
- **Use This MAC Address.** Enter the MAC address that you want to use.

Attached Devices

Use the Attached Device screen to view all computers or devices that are currently connected to your network.

➤ To go to the Attached Devices screen:

1. From the Basic Home screen, select **Attached Devices** to display the following screen:

#	IP Address	MAC Address	Device Name
1	192.168.1.2	F0:DE:F1:70:2D:13	ALEX-THINK

Wired devices are connected to the router with Ethernet cables. Wireless devices have joined the wireless network.

- **# (number).** The order in which the device joined the network.
 - **IP Address.** The IP address that the router assigned to this device when it joined the network. This number can change if a device is disconnected and rejoins the network.
 - **MAC Address.** The unique MAC address for each device does not change. The MAC address is typically shown on the product label.
 - **Device Name.** If the device name is known, it is shown here.
2. You can click **Refresh** to update this screen.

Parental Controls

The first time you select Parental Controls from the Basic Home screen, your browser goes to the Parental Controls website. You can learn more about Live Parental Controls or download the application.



➤ To set up Live Parental Controls:

1. Select **Parental Controls** on the Dashboard screen.
2. Click either the **Windows Users** or **Mac Users** button.
3. Follow the onscreen instructions to download and install the NETGEAR Live Parental Controls Management Utility.

After installation, Live Parental Controls automatically starts.



- Click **Next**, read the note, and click **Next** again to proceed.

Because Live Parental Controls uses free OpenDNS accounts, you are prompted to log in or create a free account.

Setting up Live Parental Controls

Welcome, this setup wizard will quickly configure NETGEAR Live Parental Controls Powered by OpenDNS on your NETGEAR router.

In order to use Live Parental Controls, you need a free OpenDNS account. Do you already have one?

Yes, use my existing OpenDNS account.
 No, I need to create a free OpenDNS account.

- Select the radio button that applies to you and click **Next**.
 - If you already have an OpenDNS account, leave the **Yes** radio button selected.
 - If you do not have an OpenDNS account, select the **No** radio button.

If you are creating an account, the following screen displays:

Create a free OpenDNS account

Username

Password

Confirm Password

Email

Confirm Email

- Fill in the fields and click **Next**.

After you log on or create your account, the filtering level screen displays:

Live Parental Controls: choose a filtering level for your network

All computers connected to your router will be protected from the content you select below. You can customize your Live Parental Controls later on our website.

High
 Protects against all adult-related sites, illegal activity, social networking sites, video sharing sites, phishing attacks and general time-wasters.

Moderate
 Protects against all adult-related sites, illegal activity and phishing attacks.

Low
 Protects against pornography and phishing attacks.

Minimal
 Protects only against phishing attacks.

None
 Nothing blocked.

6. Select the radio button for the filtering level that you want and click **Next**.

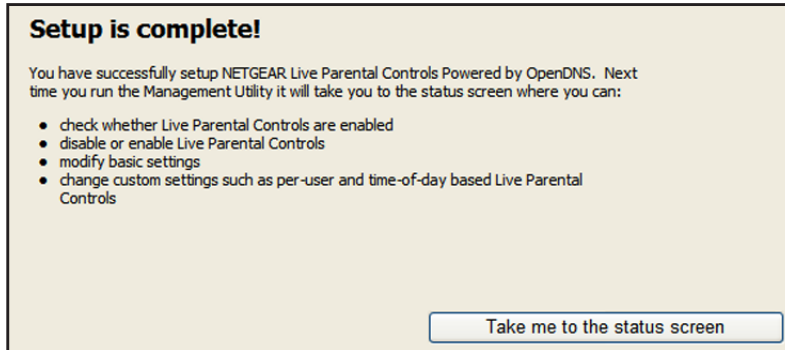

7. Click the **Take me to the status screen** button.

Parental controls are now set up for the router. The Dashboard shows Parental Controls as Enabled.

Basic Wireless Settings

The Wireless Settings screen lets you view or configure the wireless network setup.

The N150 2-Port Wireless Router comes with preset security. This means that the Wi-Fi network name (SSID), network key (password), and security option (encryption protocol) are preset in the factory. You can find the preset SSID and password on the bottom of the unit.

Note: The preset SSID and password are uniquely generated for every device to protect and maximize your wireless security.

➤ To view or change basic wireless settings:

NETGEAR recommends that you do not change your preset security settings. If you change your preset security settings, make a note of the new settings and store it in a safe place where you can easily find it.

If you use a wireless computer to change the wireless network name (SSID) or other wireless security settings, you are disconnected when you click Apply. To avoid this problem, use a computer with a wired connection to access the router.

1. On the Basic Home screen, select **Wireless** to display the Wireless Settings screen.

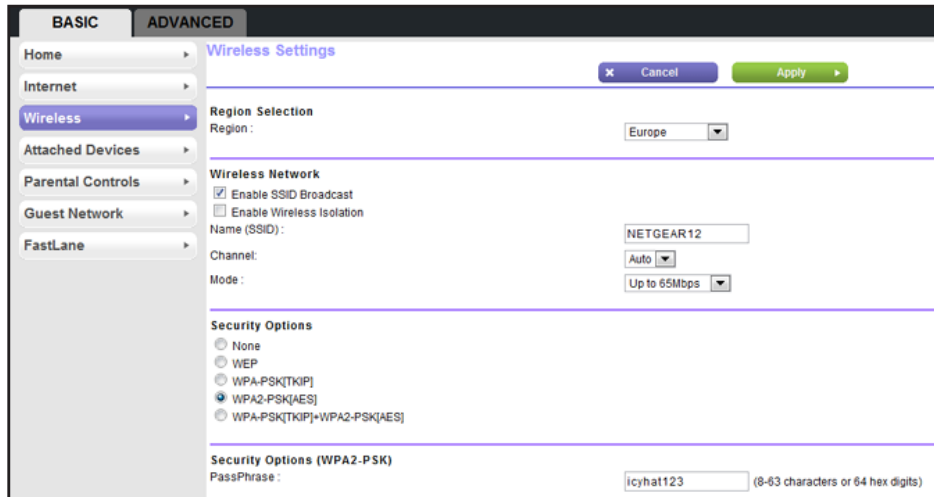

The screen sections, settings, and procedures are explained in the following sections.

2. Make any changes that are needed and click **Apply** to save your settings.
3. Set up and test your wireless devices and computers to make sure that they can connect wirelessly. If they do not, check the following:
 - Is your wireless device or computer connected to your network or another wireless network in your area? Some wireless devices automatically connect to the first open network (without wireless security) that they discover.
 - Does your wireless device or computer show up on the Attached Devices screen? If it does, then it is connected to the network.
 - If you are not sure what the network name (SSID) or password is, look on the label on the bottom of your router.

Wireless Settings Screen Fields

Region Selection

The location where the router is used. Select from the countries in the list. In the United States, the region is fixed to United States and is not changeable.

Wireless Network

Enable Wireless Isolation. If this check box is selected, then computers or wireless devices that join the network can use the Internet, but cannot access each other or access Ethernet devices on the network.

Enable SSID Broadcast. This setting allows the router to broadcast its SSID so wireless stations can see this wireless name (SSID) in their scanned network lists. This check box is selected by default. To turn off the SSID broadcast, clear the **Allow Broadcast of Name (SSID)** check box, and click **Apply**.

Name (SSID). The SSID is also known as the wireless network name. Enter a 32-character (maximum) name in this field. This field is case-sensitive. The default SSID is randomly generated, and *NETGEAR strongly recommends that you do not change this setting.*

Channel. This setting is the wireless channel the gateway uses. Enter a value from 1 through 13. (For products in the North America market, only Channels 1 through 11 can be operated.) Do not change the channel unless you experience interference (shown by lost connections or slow data transfers). If this happens, experiment with different channels to see which is the best.

Mode. Up to 150 Mbps is the default setting. The options are:

- Up to 54 Mbps. This legacy mode uses a maximum speed of Mbps for b/g networks.
- Up to 65 Mbps. This neighbor-friendly mode does not interfere with neighboring wireless networks.
- Up to 150 Mbps. Performance mode uses the maximum wireless-N speed of up to 150 Mbps.

Security Options Settings

The Security Options section of the Wireless Settings screen lets you change the security option and passphrase. *NETGEAR recommends that you do not change the security option or passphrase, but if you want to change these settings, this section explains how. Do not disable security.*

Change WPA Security Option and Passphrase

You can change the security settings for your router. If you do so, then write down the new settings and store them in a secure place for future reference.

➤ **To change the WPA settings:**

1. Under Security Options, select the WPA option you want.

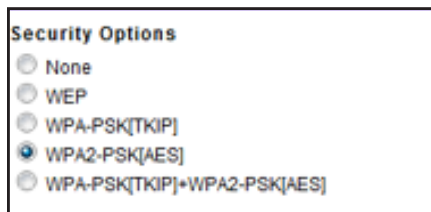

2. In the Passphrase field that displays when you select a WPA security option, enter the network key (passphrase) that you want to use. It is a text string from 8 to 63 characters.

Guest Networks

Adding a guest network allows visitors at your home to use the Internet without giving them your wireless security key.

➤ **To set up a guest network:**

1. Select **Basic > Guest Network** to display the following screen:

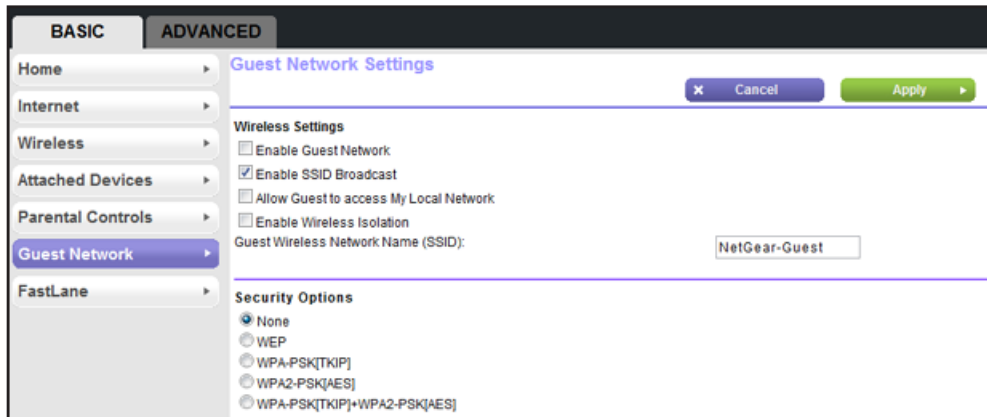

2. Select any of the following wireless settings:

Enable Guest Network. When this check box is selected, the guest network is enabled, and guests can connect to your network using the SSID of this profile.

Enable Wireless Isolation. If this check box is selected, wireless clients (computers or wireless devices) that join the network can use the Internet. However, the wireless clients cannot access each other or access Ethernet devices on the network.

Enable SSID Broadcast. If this check box is selected, the wireless access point broadcasts its name (SSID) to all wireless stations. Stations with no SSID can adopt the correct SSID for connections to this access point.

Allow guest to access My Local Network. If this check box is selected, any user who connects to this SSID has access to your local network, not just Internet access.

3. Give the guest network a name.

The guest network name is case-sensitive and can be up to 32 characters. You then manually configure the wireless devices in your network to use the guest network name in addition to the main nonguest SSID.

4. Select a security option from the list. The security options are described in [Guest Network Wireless Security Options](#) on page 28.
5. Click **Apply** to save your selections.

Guest Network Wireless Security Options

A security option is the type of security protocol applied to your wireless network. The security protocol in force encrypts data transmissions and ensures that only trusted devices receive authorization to connect to your network. Wi-Fi Protected Access (WPA) has several options including pre-shared key (PSK) encryption.

This section presents an overview of the security options and provides guidance on when to use which option. It is possible to set up a guest network without wireless security. NETGEAR does *not* recommend this.

WPA Encryption

WPA encryption is built into all hardware that has the Wi-Fi-certified seal. This seal means the product is authorized by the Wi-Fi Alliance (<http://www.wi-fi.org/>) because it complies with the worldwide single standard for high-speed wireless local area networking.

WPA uses a passphrase to perform authentication and generate the initial data encryption keys. Then it dynamically varies the encryption key. WPA-PSK uses Temporal Key Integrity Protocol (TKIP) data encryption, implements most of the IEEE 802.11i standard, and is designed to work with all wireless network interface cards, but not all wireless access points. It is superseded by WPA2-PSK.

WPA2-PSK is stronger than WPA-PSK. It is advertised to be theoretically indecipherable due to the greater degree of randomness in encryption keys that it generates. WPA2-PSK gets higher speed because it is usually implemented through hardware, while WPA-PSK is usually implemented through software. WPA2-PSK uses a passphrase to authenticate and generate the initial data encryption keys. Then it dynamically varies the encryption key.

WPS-PSK + WPA2-PSK Mixed Mode can provide broader support for all wireless clients. WPA2-PSK clients get higher speed and security, and WPA-PSK clients get decent speed and security.

FastLane

You can use the FastLane feature to reserve bandwidth on the router for a trusted IP address that you specify. The first time you turn on Fast Lane, you should specify the bandwidth you want to reserve and set up the push button for Fast Lane.

This prevents others from using up your bandwidth. When you connect to the router from the trusted IP address, you have guaranteed bandwidth for video steaming applications.

➤ **To set up the FastLane feature:**

1. On the Basic Home tab, select **FastLane**:

FastLane

FastLane Status: Off

Turn On FastLane

Bandwidth Reserved for Trusted IP Address 50%

Trusted IP Address 192 . 168 . 1 . 2

2. Select the **Turn On FastLane** check box.
3. Select the bandwidth to be reserved from the drop-down list.
There are 4 options: 50%, 60%, 70%, and 80%.
4. Enter the trusted IP address.
5. Click **Apply**.

4 NETGEAR genie Advanced Home

4

Specifying custom settings

This chapter contains the following sections:

- *NETGEAR genie Advanced Screen*
- *Setup Wizard*
- *WPS Wizard*
- *Setup Menu*
- *WAN Setup*
- *LAN Setup*
- *Quality of Service (QoS) Setup*

Some selections on the Advanced Home screen are described in separate chapters:

- **Security.** See *Chapter 5, Security*.
- **Administration.** See *Chapter 6, Administration*.
- **Advanced Setup.** See *Chapter 7, Advanced Settings*.

NETGEAR genie Advanced Screen

The genie Advanced Home screen is shown in the following figure:

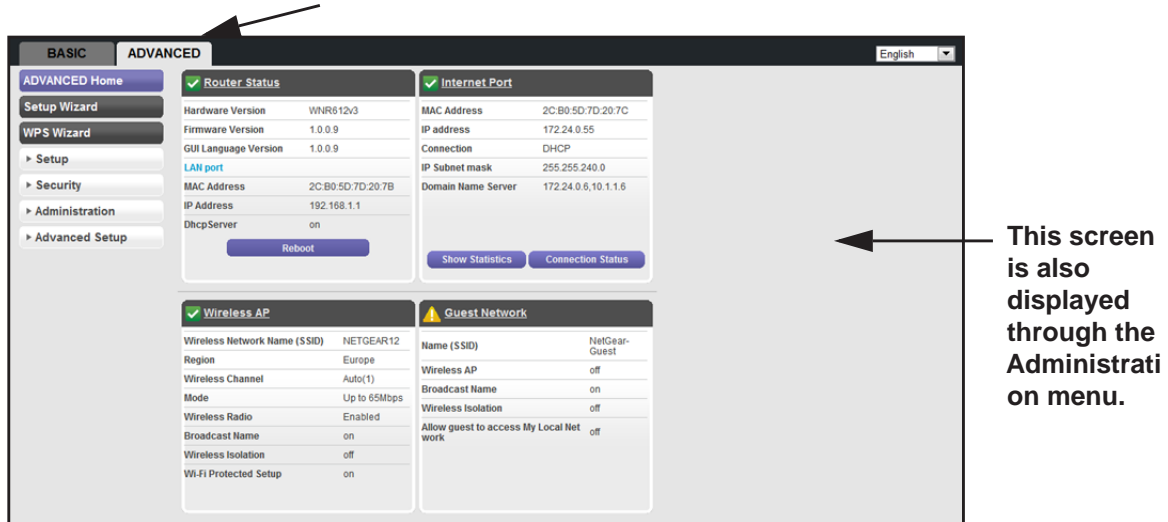

Setup Wizard

You can use the Setup Wizard to detect your Internet settings and automatically set up your router. The Setup Wizard is not the same as the genie screens that display the first time you connect to your router to set it up.

➤ To use the Setup Wizard:

1. Select **Advanced > Setup Wizard** to display the following screen:

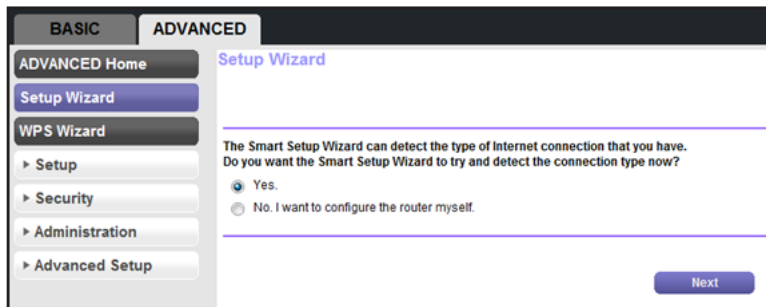

2. Select either **Yes** or **No, I want to configure the router myself**. If you select No, you are taken to the Internet Setup screen (see [Internet Settings](#) on page 19).

- If you selected Yes, click **Next**. The following screen displays:

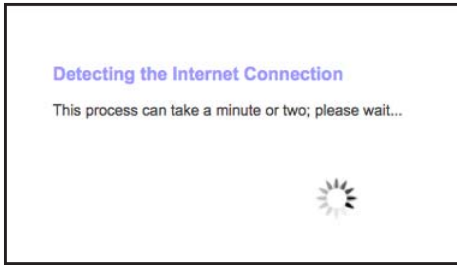

The Setup Wizard searches your Internet connection for servers and protocols to determine your ISP configuration. The following screen displays:

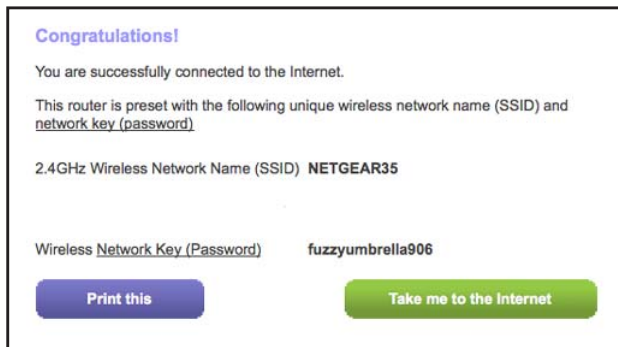

WPS Wizard

The WPS Wizard helps you add a WPS-capable client device (a wireless device or computer) to your network. On the client device, either press its WPS button or locate its WPS PIN.

- **To use the WPS Wizard:**

- Select **Advanced > WPS Wizard**.
- Click **Next**. The following screen lets you select the method for adding the WPS client (a wireless device or computer).

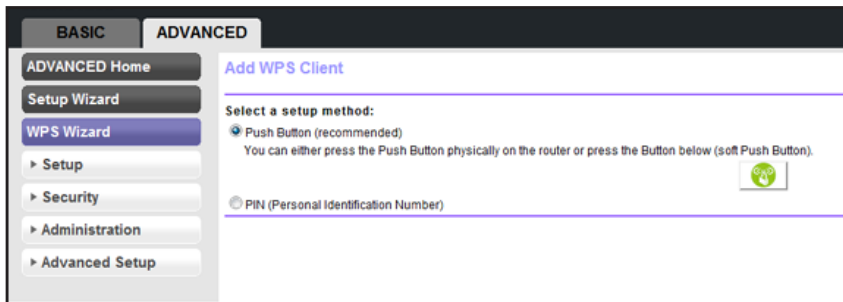

You can use either the push button or PIN method.

- Select either **Push Button** or **PIN Number**.

- To use the push button method, either click the **WPS** button on this screen or press the **WPS** button on the side of the router. Within 2 minutes, go to the wireless client and press its **WPS** button to join the network without entering a password.
- To use the PIN method, select the **PIN Number** radio button, enter the client security PIN, and click **Next**.

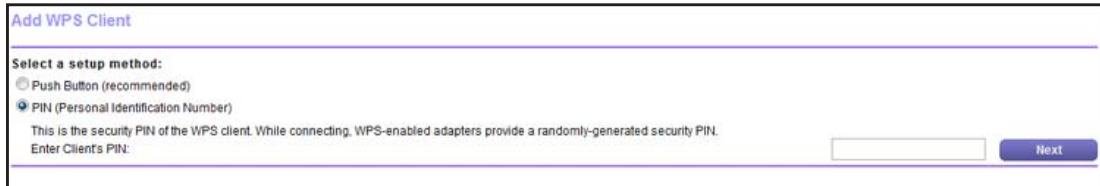

Within 2 minutes, go to the client device and use its WPS software to join the network without entering a password.

The router attempts to add the WPS-capable device.

4. Repeat Step 2 and Step 3 to add another WPS client to your network.

Setup Menu

➤ To display the Setup menu:

Select **Advanced > Setup** to display the Setup menu.

The following selections are available:

- **Internet Setup.** Go to the same Internet Setup screen that you can access from the dashboard on the Basic Home screen. See [Internet Settings](#) on page 19.
- **Wireless Setup.** Go to the same Wireless Settings screen that you can access from the dashboard on the Basic Home screen. See [Basic Wireless Settings](#) on page 24.
- **Guest Network.** This is a shortcut to the same Guest Network screen that you can access from the dashboard on the Basic Home screen. See [FastLane](#) on page 29.
- **WAN Setup.** Internet (WAN) setup. See [WAN Setup](#) on page 33.
- **LAN Setup.** Local area network (LAN) setup. See [LAN Setup](#) on page 37.
- **QoS Setup.** Quality of Service (QoS) setup. See [Quality of Service \(QoS\) Setup](#) on page 40.

WAN Setup

The WAN Setup screen lets you configure a DMZ (demilitarized zone) server, change the Maximum Transmit Unit (MTU) size, and enable the router to respond to a ping on the WAN (Internet) port.

➤ **To view or change the WAN settings:**

Select **Advanced > Setup > WAN Setup**:

The screenshot shows the WAN Setup configuration page. On the left is a navigation menu with options like 'ADVANCED Home', 'Setup Wizard', 'WPS Wizard', and 'Setup'. Under 'Setup', there are sub-menus for 'Internet Setup', 'Wireless Setup', 'Guest Network', 'WAN Setup' (highlighted), 'LAN Setup', and 'QoS Setup'. The main content area is titled 'WAN Setup' and contains several settings:

- Disable Port Scan and DOS Protection
- Default DMZ Server: 192 . 168 . 1 .
- Respond to Ping on Internet Port
- Disable IGMP Proxying
- MTU Size (in bytes): 1500
- NAT Filtering: Secured Open
- Disable SIP ALG

 At the top right of the main area are 'Cancel' and 'Apply' buttons.

The following settings are available:

- **Disable Port Scan and DoS Protection.** DoS protection protects your LAN against denial of service attacks such as Syn flood, Smurf Attack, Ping of Death, Teardrop Attack, UDP Flood, ARP Attack, Spoofing ICMP, Null Scan, and many others. This should be disabled only in special circumstances.
- **Default DMZ Server.** This feature is sometimes helpful when you are playing online games or videoconferencing. Be careful when using this feature because it makes the firewall security less effective. See the following section, [Default DMZ Server](#), for more details.
- **Respond to Ping on Internet Port.** If you want the router to respond to a ping from the Internet, select this check box. Use this setting only as a diagnostic tool because it allows your router to be discovered. Do not select this check box unless you have a specific reason.
- **Disable IGMP Proxying.** IGMP proxying allows a computer on the local area network (LAN) to receive the multicast traffic it is interested in from the Internet. If you do not need this feature, you can select this check box to disable it.
- **MTU Size (in bytes).** The normal MTU (Maximum Transmit Unit) value for most Ethernet networks is 1500 bytes, or 1492 bytes for PPPoE connections. For some ISPs, you might need to reduce the MTU. This is rarely required, and should not be done unless you are sure it is necessary for your ISP connection. See [Change the MTU Size](#) on page 35.
- **NAT Filtering.** Network Address Translation (NAT) determines how the router processes inbound traffic. Secured NAT provides a secured firewall to protect the computers on the LAN from attacks from the Internet, but might prevent some Internet games, point-to-point applications, or multimedia applications from functioning. Open NAT provides a much less secured firewall, but allows almost all Internet applications to function.

Default DMZ Server

The default DMZ server feature is helpful when you are using some online games and videoconferencing applications that are incompatible with Network Address Translation (NAT). The router is programmed to recognize some of these applications and to work correctly with them, but there are other applications that might not function well. In some cases, one local computer can run the application correctly if that computer's IP address is entered as the default DMZ server.



WARNING!

DMZ servers pose a security risk. A computer designated as the default DMZ server loses much of the protection of the firewall and is exposed to exploits from the Internet. If compromised, the DMZ server computer can be used to attack other computers on your network.

The router usually detects and discards Incoming traffic from the Internet that is not a response to one of your local computers or a service that you have configured in the Port Forwarding/Port Triggering screen. Instead of discarding this traffic, you can have the router forward the traffic to one computer on your network. This computer is called the default DMZ server.

➤ To set up a default DMZ server:

1. On the WAN Setup screen, select the **Default DMZ Server** check box.
2. Type the IP address.
3. Click **Apply**.

Change the MTU Size

The maximum transmission unit (MTU) is the largest data packet a network device transmits. When one network device communicates across the Internet with another, the data packets travel through many devices along the way. If a device in the data path has a lower MTU setting than the other devices, the data packets have to be split or "fragmented" to accommodate the device with the smallest MTU.

The best MTU setting for NETGEAR equipment is often just the default value. In some situations, changing the value fixes one problem but causes another. Leave the MTU unchanged unless one of these situations occurs:

- You have problems connecting to your ISP or other Internet service, and the technical support of either the ISP or NETGEAR recommends changing the MTU setting. These web-based applications might require an MTU change:
 - A secure website that does not open, or displays only part of a web page
 - Yahoo email
 - MSN portal

- America Online's DSL service
- You use VPN and have severe performance problems.
- You used a program to optimize MTU for performance reasons, and now you have connectivity or performance problems.

Note: An incorrect MTU setting can cause Internet communication problems. For instance, you might not be able to access certain websites, frames within websites, secure login pages, or FTP or POP servers.

If you suspect an MTU problem, a common solution is to change the MTU to 1400. If you are willing to experiment, you can gradually reduce the MTU from the maximum value of 1500 until the problem goes away. The following table describes common MTU sizes and applications.

Table 2. Common MTU Sizes

MTU	Application
1500	The largest Ethernet packet size and the default value. This setting is typical for connections that do not use PPPoE or VPN, and is the default value for NETGEAR routers, adapters, and switches.
1492	Used in PPPoE environments.
1472	Maximum size to use for pinging. (Larger packets are fragmented.)
1468	Used in some DHCP environments.
1460	Usable by AOL if you do not have large email attachments, for example.
1436	Used in PPTP environments or with VPN.
1400	Maximum size for AOL DSL.
576	Typical value to connect to dial-up ISPs.

➤ **To change the MTU size:**

1. Select **Advanced > Setup > WAN Setup**.
2. In the MTU Size field, enter a value from 64 to 1500.
3. Click **Apply** to save the settings.

LAN Setup

The LAN Setup screen allows configuration of LAN IP services such as Dynamic Host Configuration Protocol (DHCP) and Routing Information Protocol (RIP).

The router is shipped preconfigured to use private IP addresses on the LAN side and to act as a DHCP server. The router's default LAN IP configuration is:

- LAN IP address. **192.168.1.1**
- Subnet mask. **255.255.255.0**

These addresses are part of the designated private address range for use in private networks and are suitable for most applications. If your network requires a different IP addressing scheme, you can change these settings in the LAN Setup screen.

➤ To change the LAN settings:

Note: If you change the LAN IP address of the router while connected through the browser, you will be disconnected. You will have to open a new connection to the new IP address and log in again.

1. Select **Advanced > Setup > LAN Setup** to display the following screen:

The screenshot shows the LAN Setup screen in the Advanced Home tab. The left sidebar contains navigation options: ADVANCED Home, Setup Wizard, WPS Wizard, Setup (expanded), Internet Setup, Wireless Setup, Guest Network, WAN Setup, LAN Setup (selected), QoS Setup, Security, Administration, and Advanced Setup. The main content area is titled 'LAN Setup' and includes a 'Cancel' button and an 'Apply' button. The configuration fields are as follows:

- Device Name: WNR612v3
- LAN TCP/IP Setup:
 - IP Address: 192.168.1.1
 - IP Subnet Mask: 255.255.255.0
 - RIP Direction: Both
 - RIP Version: Disabled
- Use Router as DHCP Server
 - Starting IP Address: 192.168.1.2
 - Ending IP Address: 192.168.1.254
- Address Reservation table:

#	IP Address	Device Name	MAC Address

2. Enter the settings that you want to customize. These settings are described in the following section, [LAN Setup Screen Settings](#).
3. Click **Apply** to save your changes.

LAN Setup Screen Settings

LAN TCP/IP Setup

- **IP Address.** The LAN IP address of the router.
- **IP Subnet Mask.** The LAN subnet mask of the router. Combined with the IP address, the IP subnet mask allows a device to know which other addresses are local to it, and which addresses have to be reached through a gateway or router.
- **RIP Direction.** Router Information Protocol (RIP) allows a router to exchange routing information with other routers. This setting controls how the router sends and receives RIP packets. Both is the default setting. With the Both or Out Only setting, the router broadcasts its routing table periodically. With the Both or In Only setting, the router incorporates the RIP information that it receives.
- **RIP Version.** This setting controls the format and the broadcasting method of the RIP packets that the router sends. It recognizes both formats when receiving. By default, the RIP function is disabled.

RIP-1 is universally supported. It is adequate for most networks, unless you have an unusual network setup.

RIP-2 carries more information. Both RIP-2B and RIP-2M send the routing data in RIP-2 format. RIP-2B uses subnet broadcasting. RIP-2M uses multicasting.

Use Router as a DHCP Server

This check box is selected by default so that the router functions as a Dynamic Host Configuration Protocol (DHCP) server.

- **Starting IP Address.** Specify the start of the range for the pool of IP addresses in the same subnet as the router.
- **Ending IP Address.** Specify the end of the range for the pool of IP addresses in the same subnet as the router.

Address Reservation

When you specify a reserved IP address for a computer on the LAN, that computer receives the same IP address each time it accesses the router's DHCP server. Assign reserved IP addresses to servers that require permanent IP settings.

Use the Router as a DHCP Server

By default, the router acts as a DHCP server. The router assigns IP, DNS server, and default gateway addresses to all computers connected to the LAN. The assigned default gateway address is the LAN address of the router. The router assigns IP addresses to the attached computers from a pool of addresses specified in this screen. Each pool address is tested before it is assigned to avoid duplicate addresses on the LAN. For most applications, the default DHCP and TCP/IP settings of the router are satisfactory.

You can specify the pool of IP addresses to be assigned by setting the starting IP address and ending IP address. These addresses should be part of the same IP address subnet as the router's LAN IP address. Using the default addressing scheme, define a range between 192.168.1.2 and 192.168.1.254, although you might want to save part of the range for devices with fixed addresses.

The router delivers the following parameters to any LAN device that requests DHCP:

- An IP address from the range you have defined
- Subnet mask
- Gateway IP address (the router's LAN IP address)
- Primary DNS server (if you entered a primary DNS address in the Internet Setup screen; otherwise, the router's LAN IP address)
- Secondary DNS server (if you entered a secondary DNS address in the Internet Setup screen)

To use another device on your network as the DHCP server, or to specify the network settings of all of your computers, clear the **Use Router as DHCP Server** check box and click **Apply**. Otherwise, leave this check box selected. If this service is not enabled and no other DHCP server is available on your network, set your computer IP addresses manually so that it can access the router.

Address Reservation

When you specify a reserved IP address for a computer on the LAN, that computer always receives the same IP address each time it accesses the router's DHCP server. Assign reserved IP addresses to computers or servers that require permanent IP settings.

➤ To reserve an IP address:

1. In the Address Reservation section of the screen, click the **Add** button.
2. In the IP Address field, type the IP address to assign to the computer or server. (Choose an IP address from the router's LAN subnet, such as 192.168.1.x.)
3. Type the MAC address of the computer or server.

Tip: If the computer is already on your network, you can copy its MAC address from the Attached Devices screen and paste it here.

4. Click **Apply** to enter the reserved address into the table.

The reserved address is not assigned until the next time the computer contacts the router's DHCP server. Reboot the computer, or access its IP configuration and force a DHCP release and renew.

To edit or delete a reserved address entry, select the radio button next to the reserved address you want to edit or delete. Then click **Edit** or **Delete**.

Quality of Service (QoS) Setup

QoS is an advanced feature that can be used to prioritize some types of traffic ahead of others. The N150 2-Port Wireless Router can provide QoS prioritization over the wireless link and on the Internet connection. To configure QoS, use the QoS Setup screen.

➤ To go to the QoS Setup screen:

Select **Advanced > Setup > QoS Setup** to display the following screen:

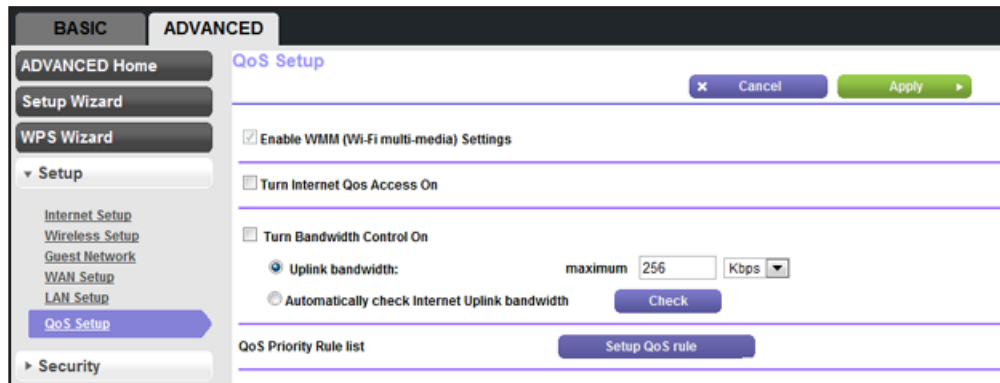

Enable WMM QoS for Wireless Multimedia Applications

The N150 2-Port Wireless Router supports Wi-Fi Multimedia Quality of Service (WMM QoS) to prioritize wireless voice and video traffic over the wireless link. WMM QoS provides prioritization of wireless data packets from different applications based on four access categories: voice, video, best effort, and background. For an application to receive the benefits of WMM QoS, both it and the client running that application have to have WMM enabled. Legacy applications that do not support WMM and applications that do not require QoS, are assigned to the best effort category, which receives a lower priority than voice and video.

WMM QoS is enabled by default. You can disable it in the QoS Setup screen by clearing the **Enable WMM** check box and clicking **Apply**.

Set Up QoS for Internet Access

You can give prioritized Internet access to the following types of traffic:

- Specific applications
- Specific online games
- Individual Ethernet LAN ports of the router
- A specific device by MAC address

To specify prioritization of traffic, create a policy for the type of traffic and add the policy to the QoS Policy table in the QoS Setup screen. For convenience, the QoS Policy table lists many common applications and online games that can benefit from QoS handling.

QoS for Applications and Online Gaming

- To create a QoS policy for applications and online games:
 1. In the QoS Setup screen, select the **Turn Internet Access QoS On** check box.
 2. Click the **Setup QoS Rule** button to see the existing priority rules.

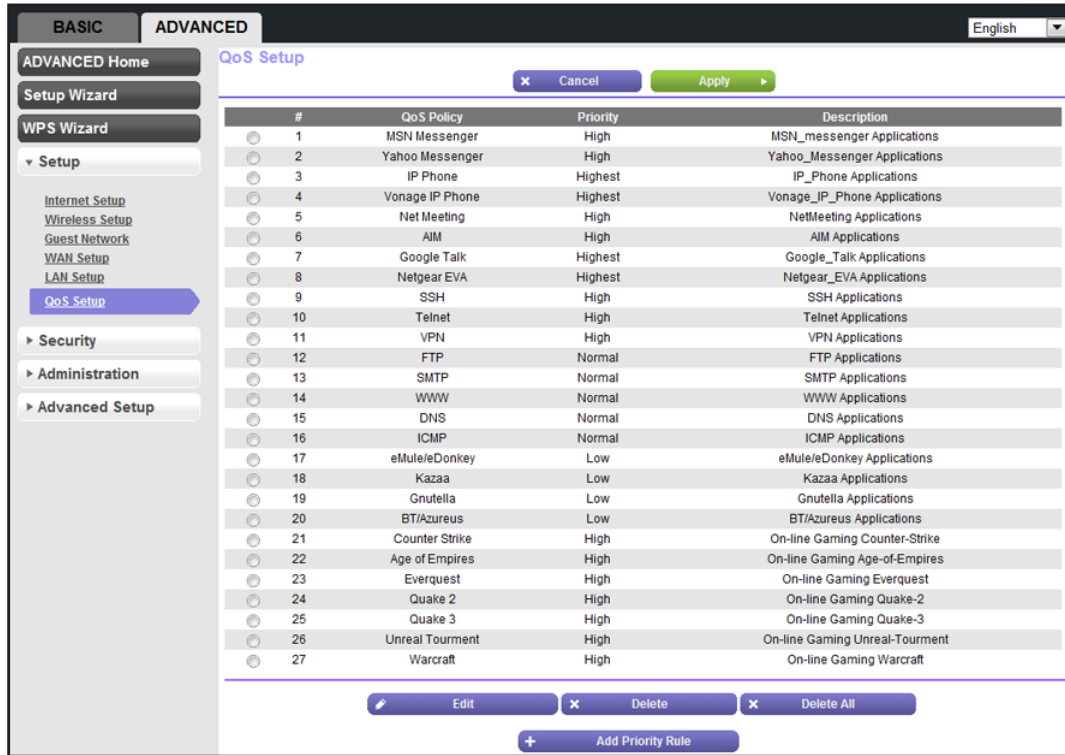

You can edit or delete a rule by selecting its radio button and clicking either the **Edit** or **Delete** button. You can also delete all of the rules by simply clicking the **Delete All** button.

3. To add a priority rule, scroll down to the bottom of the QoS Setup screen and click **Add Priority Rule** to display the following screen:

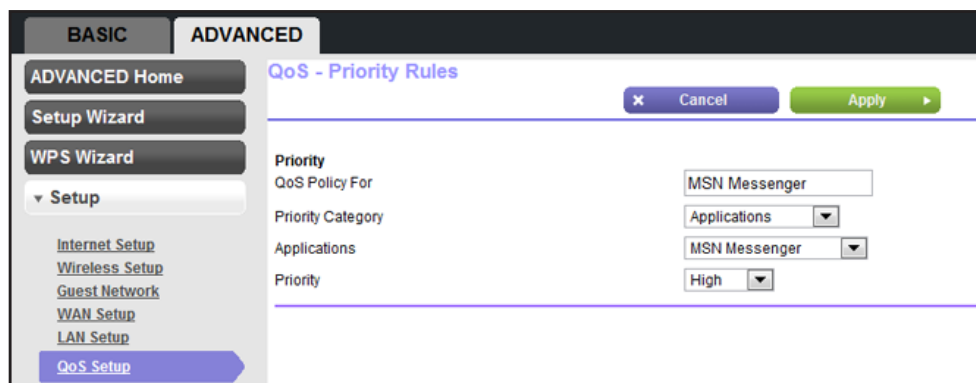

4. In the QoS Policy for field, type the name of the application or game.
5. In the Priority Category list, select either **Applications** or **Online Gaming**. In either case, a list of applications or games displays in the list.

6. You can select an existing item from the list, or you can scroll and select **Add a New Application** or **Add a New Game**, as applicable.
 - a. If you add an entry, the Priority Rules screen expands as shown:

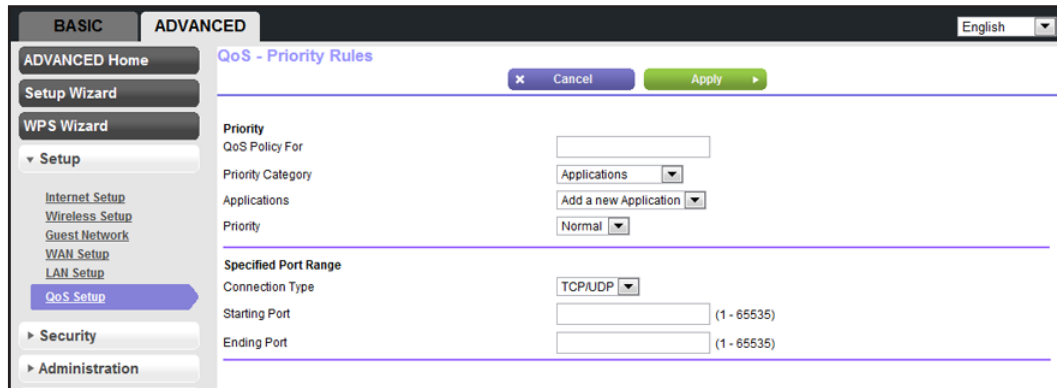

- b. In the QoS Policy for field, enter a descriptive name for the new application or game.
 - c. In the Connection Type list, select either **TCP**, **UDP**, or both (**TCP/UDP**). Specify the port number or range of port numbers that the application or game uses.
7. From the Priority list, select the priority for Internet access for this traffic relative to other applications and traffic. The options are Low, Normal, High, and Highest.
8. Click **Apply** to save this rule to the QoS Policy list and return to the QoS Setup screen.

QoS for a Router LAN Port

- To create a QoS policy for a device connected to one of the router's LAN ports:
 1. Select **Advanced > Setup > QoS Setup** to display the QoS Setup screen.
 2. Select the **Turn Internet Access QoS On** check box.
 3. Click the **Setup QoS Rule** button.
 4. Click the **Add Priority Rule** button.
 5. From the Priority Category list, select **Ethernet LAN Port**, as shown in the following figure:

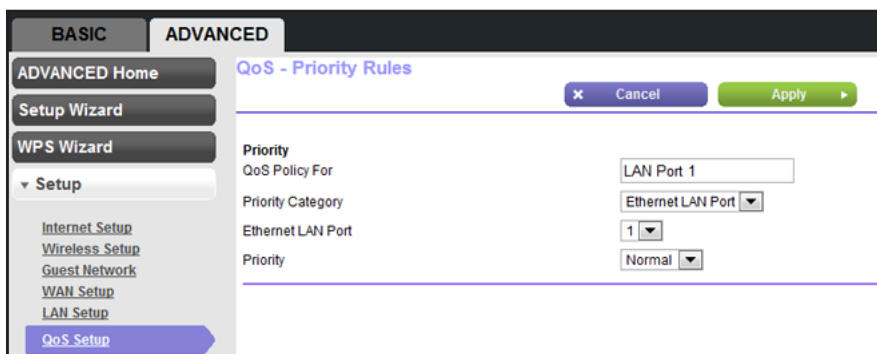

6. From the LAN port list, select the LAN port.
 7. From the Priority list, select the priority for Internet access for this port's traffic relative to other applications. The options are Low, Normal, High, and Highest.

8. Click **Apply** to save this rule to the QoS Policy list and return to the QoS Setup screen.
9. In the QoS Setup screen, click **Apply**.

QoS for a MAC Address

- **To create a QoS policy for traffic from a specific MAC address:**
 1. Select **Advanced > Setup > QoS Setup**.
 2. Click the **Setup QoS Rule** button. The QoS Setup screen displays.
 3. Click **Add Priority Rule**.
 4. From the Priority Category list, select **MAC Address**:

5. If the device is the MAC Device List, select its radio button. The information from the MAC Device List populates the policy name, MAC Address, and Device Name fields. If the device is not in the list, click **Refresh**. If it still does not appear, fill in these fields manually.
6. From the Priority list, select the priority for Internet access for this device's traffic relative to other applications and traffic. The options are Low, Normal, High, and Highest.
7. Click **Apply** to save this rule to the QoS Policy list and return to the QoS Setup screen.
8. In the QoS Setup screen, select the **Turn Internet Access QoS On** check box.
9. Click **Apply**.

Edit or Delete an Existing QoS Policy

- **To edit or delete a QoS policy:**
 1. Select **Advanced > QoS Setup** to display the QoS Setup screen.
 2. Select the radio button next to the QoS policy that you want to edit or delete, and do one of the following:
 - Click **Delete** to remove the QoS policy.
 - Click **Edit** to edit the QoS policy. Follow the instructions in the preceding sections to change the policy settings.
 3. Click **Apply** in the QoS Setup screen to save your changes.

5 Security

5

Keeping unwanted content out of your network

This chapter explains how to use the basic firewall features of the router to prevent objectionable content from reaching the computers and devices on your network.

This chapter includes the following sections:

- *Keyword Blocking of HTTP Traffic*
- *Block Services (Port Filtering)*
- *Schedule Blocking*
- *Security Event Email Notifications*

Keyword Blocking of HTTP Traffic

Use keyword blocking to prevent certain types of HTTP traffic from accessing your network. The blocking can be always or according to a schedule.

➤ To set up keyword blocking:

1. Select **Advanced > Security > Block Sites** to display the following screen:

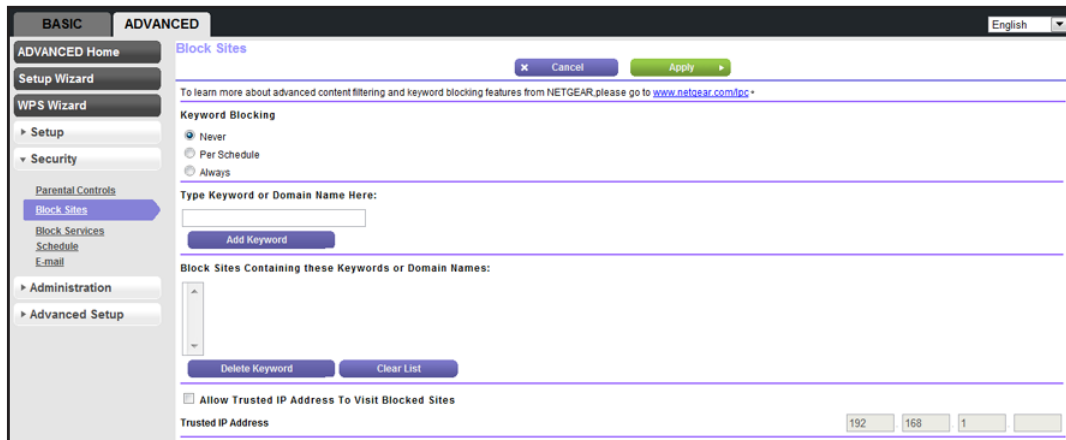

2. Select one of the keyword blocking options:
 - **Per Schedule.** Turn on keyword blocking according to the Schedule screen settings.
 - **Always.** Turn on keyword blocking all the time, independent of the Schedule screen.
3. In the Keyword field, enter a keyword or domain, click **Add Keyword**, and click **Apply**.
The Keyword list supports up to 32 entries. Here are some sample entries:
 - Specify XXX to block <http://www.badstuff.com/xxx.html>.
 - Specify .com if you want to allow only sites with domain suffixes such as .edu or .gov.
 - Enter a period (.) to block all Internet browsing access.

➤ To delete a keyword or domain:

1. Select the keyword you want to delete from the list.
2. Click **Delete Keyword**, and then **Apply** to save your changes.

➤ To specify a trusted computer:

You can exempt one trusted computer from blocking and logging. The computer you exempt has to have a fixed IP address.

1. In the Trusted IP Address field, enter the IP address.
2. Click **Apply** to save your changes.

Block Services (Port Filtering)

Services are functions that server computers perform at the request of client computers. For example, web servers serve web pages, time servers serve time and date information, and game hosts serve data about other players' moves. When a computer on the Internet sends a request for service to a server computer, the requested service is identified by a service or port number. This number appears as the destination port number in the transmitted IP packets. For example, a packet that is sent with the destination port number 80 is an HTTP (web server) request.

The service numbers for many common protocols are defined by the Internet Engineering Task Force (IETF at <http://www.ietf.org/>) and published in RFC1700, "Assigned Numbers." Service numbers for other applications are typically chosen from the range 1024 to 65535 by the authors of the application. Although the router already holds a list of many service port numbers, you are not limited to these choices. You can often determine port number information by contacting the publisher of the application, by asking user groups or newsgroups, or by searching.

The Block Services screen lets you add and block specific Internet services by computers on your network. This is called service blocking or port filtering. To add a service for blocking, first determine which port number or range of numbers the application uses.

➤ To block services:

1. Select **Advanced > Security > Block Services** to display the following screen:

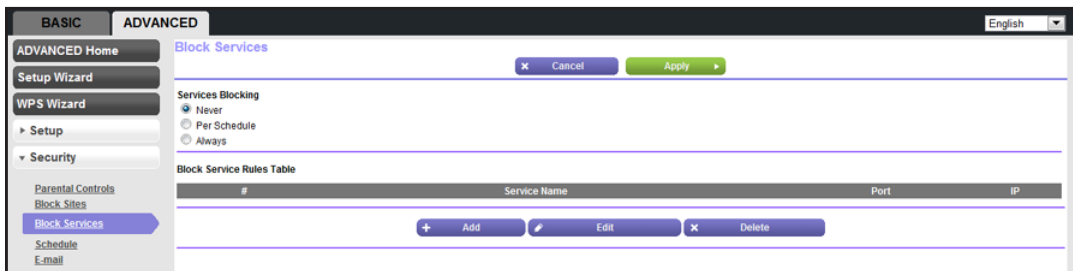

2. Select either **Per Schedule** or **Always** to enable service blocking, and click **Apply**. If you selected **Per Schedule**, specify a time period in the **Schedule** screen as described in [Schedule Blocking](#) on page 48.

3. Click **Add** to add a service. The Block Services Setup screen displays:

4. From the Service Type list, select the application or service to allow or block. The list already displays several common services, but you are not limited to these choices. To add any additional services or applications that do not already appear, select **User Defined**.
5. If you know that the application uses either TCP or UDP, select the appropriate protocol. If you are not sure, select **Both**.
6. Enter the starting and ending port numbers. If the application uses a single port number, enter that number in both fields.
7. Select the radio button for the IP address configuration you want to block, and enter the IP addresses. You can block the specified service for a single computer, a range of computers with consecutive IP addresses, or all computers on your network.
8. Click **Add** to enable your Block Services Setup selections.

Schedule Blocking

You can specify the days and time that you want to block Internet access.

➤ **To schedule blocking:**

1. Select **Advanced > Security > Schedule** to display the following screen:

2. Set up the schedule for blocking keywords and services.
 - **Days to Block.** Select days on which you want to apply blocking by selecting the appropriate check boxes, or select **Every Day** to select the check boxes for all days.
 - **Time of Day to Block.** Select a start and end time in 24-hour format, or select **All Day** for 24-hour blocking.
3. Select your time zone from the list. If you use daylight savings time, select the **Automatically adjust for daylight savings time** check box.
4. Click **Apply** to save your settings.

Security Event Email Notifications

To receive logs and alerts by email, provide your email information in the Email screen, and specify which alerts you want to receive and how often.

➤ **To set up email notifications:**

1. Select **Advanced > Security > Email** to display the following screen:

The screenshot shows the 'E-mail' configuration page. On the left is a navigation menu with 'E-mail' selected. The main content area has a title 'E-mail' and 'Cancel' and 'Apply' buttons. Below are several sections:

- Turn E-mail Notification On
- Send Alerts and Logs Via E-mail**
 - Your Outgoing Mail Server: [text input]
 - Send To This E-mail Address: [text input]
 - Your Mail Server requires authentication
 - User Name: [text input]
 - Password: [text input]
 - Send Alert Immediately
 - When Someone Attempts To Visit A Blocked Site.
- Send Logs According to this Schedule**
 - None [dropdown]
 - Day: Sunday [dropdown]
 - Time: 12:00 [dropdown] [radio] a.m. [radio] p.m.

2. To receive email logs and alerts from the router, select the **Turn Email Notification On** check box.
3. In the Your Outgoing Mail Server field, enter the name of your ISP's outgoing (SMTP) mail server (such as mail.myISP.com). You might be able to find this information in the configuration screen of your email program. If you leave this field blank, log and alert messages are not sent by email.
4. Enter the email address to which logs and alerts are sent in the Send to This Email Address field. This email address is also used for the From address. If you leave this field blank, log and alert messages are not sent by email.
5. If your outgoing email server requires authentication, select the **My Mail Server requires authentication** check box. Fill in the User Name and Password fields for the outgoing email server.
6. You can have email alerts sent immediately when someone attempts to visit a blocked site, and you can specify that logs are sent automatically.

If you select the Weekly, Daily, or Hourly option and the log fills up before the specified period, the log is emailed to the specified email address. After the log is sent, the log is cleared from the router's memory. If the router cannot email the log file, the log buffer might fill up. In this case, the router overwrites the log and discards its contents.

7. Click **Apply** to save your settings.

6 Administration

6

Managing your network

This chapter describes the router settings for administering and maintaining your router and home network. See [Remote Management](#) on page 76 for information about checking the status of your router over the Internet, and [Traffic Meter](#) on page 78 for information about monitoring Internet traffic on your router's Internet port.

This chapter includes the following sections:

- [Upgrade the Firmware](#)
- [View Router Status](#)
- [View Logs of Web Access or Attempted Web Access](#)
- [Manage the Configuration File](#)
- [Set Password](#)

Upgrade the Firmware

The router firmware (routing software) is stored in flash memory. You can update the firmware from the Administration menu on the Advanced tab. You might see a message at the top of the genie screens when new firmware is available for your product.

You can use the Check button on the Router Update screen to check and update to the latest firmware for your product if new firmware is available.

➤ **To check for new firmware and update your router:**

1. Select **Advanced > Administration > Firmware Update** to display the following screen:

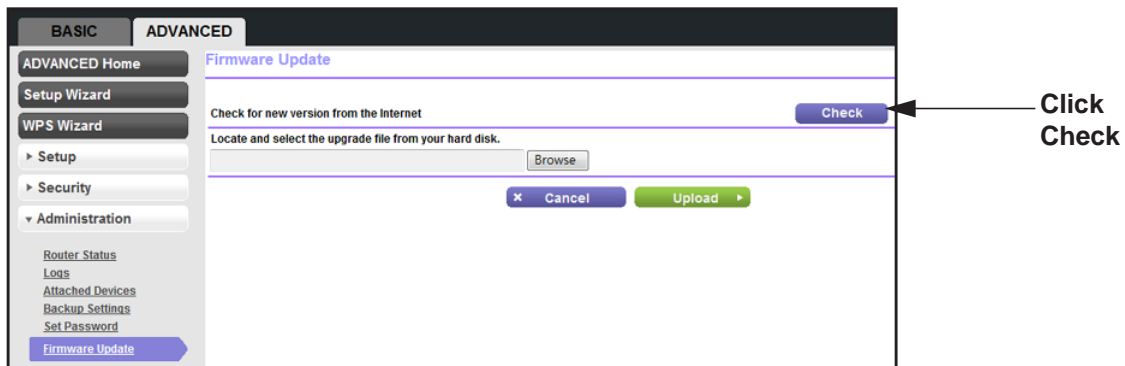

2. Click **Check**.
If new firmware is available, the router finds it.
3. Click **Yes** to update and locate the firmware you downloaded (the file ends in .img).



WARNING!

When uploading firmware to the router, **do not** interrupt the web browser by closing the window, clicking a link, or loading a new page. If the browser is interrupted, it could corrupt the firmware.

When the upload is complete, your router restarts. The upgrade process typically takes about 1 minute. Read the new firmware release notes to determine whether you need to reconfigure the router after upgrading.

View Router Status

- To view router status and usage information:

Select **Advanced Home** or select **Administration > Router Status** to display the following screen:

BASIC		ADVANCED	
<ul style="list-style-type: none"> ADVANCED Home Setup Wizard WPS Wizard Setup Security Administration <ul style="list-style-type: none"> Router Status Logs Attached Devices Backup Settings Set Password Firmware Update Advanced Setup 		Router Status <ul style="list-style-type: none"> Hardware Version: WNR612v3 Firmware Version: 1.0.0.9 GUI Language Version: 1.0.0.9 LAN port <ul style="list-style-type: none"> MAC Address: 2C:B0:5D:7D:20:7B IP Address: 192.168.1.1 DhcpServer: on Reboot 	Internet Port <ul style="list-style-type: none"> MAC Address: 2C:B0:5D:7D:20:7C IP Address: 172.24.0.55 Connection: DHCP IP Subnet mask: 255.255.240.0 Domain Name Server: 172.24.0.6,10.1.1.6 Show Statistics Connection Status
		Wireless AP <ul style="list-style-type: none"> Wireless Network Name (SSID): NETGEAR12 Region: Europe Wireless Channel: Auto(1) Mode: Up to 65Mbps Wireless Radio: Enabled Broadcast Name: on Wireless Isolation: off Wi-Fi Protected Setup: on 	Guest Network <ul style="list-style-type: none"> Name (SSID): NetGear-Guest Wireless AP: off Broadcast Name: on Wireless Isolation: off Allow guest to access My Local Network: off

Router Information

Hardware Version. The router model.

Firmware Version. The version of the router firmware. It changes if you upgrade the router firmware.

GUI Language Version. The localized language of the user interface.

LAN Port.

- **MAC Address.** The Media Access Control address is the unique physical address used by the Ethernet (LAN) port of the router.
- **IP Address.** The IP address used by the Ethernet (LAN) port of the router. The default is 192.168.1.1.
- **DHCP Server.** Identifies whether the router's built-in DHCP server is active for devices on the LAN.

Internet Provider (WAN) Setup

MAC Address. The Media Access Control address, which is the unique physical address used by the Internet (WAN) port of the router.

IP Address. The IP address used by the Internet (WAN) port of the router. If no address is shown or the address is 0.0.0, the router cannot connect to the Internet.

Connection. This shows if the router is using a fixed IP address on the WAN. If the value is DHCP Client, the router obtains an IP address dynamically from the ISP.

IP Subnet Mask. The IP subnet mask used by the Internet (WAN) port of the router.

Domain Name Server. The Domain Name Server addresses used by the router. A Domain Name Server translates human-language URLs such as www.netgear.com into IP addresses.

Statistics

➤ To view statistics:

On the Router Status screen, in the Internet Provider (WAN) Setup pane, click the **Statistics** button to display the following screen:

System Up Time 01:06:28							
Port	Status	TxPkts	RxPkts	Collisions	TX Bytes	RX Bytes	Up Time
WAN	100M/Full	14401	105026	0	3502554	12517676	00:58:19
LAN 1	LinkDown	18385	16654	0	7863355	3351648	00:00:00
LAN 2	100M/Full						00:58:28
WLAN	65Mbps	6343	382794	0	2536124	79517184	01:06:09

Poll Interval : (5-86400 secs)

The following information is displayed:

System Up Time. The time elapsed since the router was last restarted.

Port. The statistics for the WAN (Internet) and LAN (Ethernet) ports. For each port, the screen displays:

- **Status.** The link status of the port.
- **TxPkts.** The number of packets transmitted on this port since reset or manual clear.
- **RxPkts.** The number of packets received on this port since reset or manual clear.
- **Collisions.** The number of collisions on this port since reset or manual clear.
- **Tx B/s.** The current transmission (outbound) bandwidth used on the WAN and LAN ports.
- **Rx B/s.** The current reception (inbound) bandwidth used on the WAN and LAN ports.
- **Up Time.** The time elapsed since this port acquired the link.
- **Poll Interval.** The interval at which the statistics are updated in this screen.

To change the polling:

- To change the frequency, enter a time in seconds in the Poll Interval field, and click **Set Interval**.
- To stop the polling entirely, click **Stop**.

Connection Status

➤ **To view the connection status:**

On the Router Status screen in the Internet Connection pane, click the **Connection Status** button to view connection status information.

Connection Status	
IP Address	192.168.1.65
Subnet Mask	255.255.255.0
Default Gateway	192.168.1.254
DHCP Server	192.168.1.254
DNS Server	192.168.1.254
Lease Obtained	1 days,0 Hours,0 minutes.
Lease Expires	0 days,22 Hours,52 minutes.
<input type="button" value="Release"/> <input type="button" value="Renew"/>	
<input type="button" value="Close Window"/>	

The Release button returns the status of all items to 0. The Renew button refreshes the items. The Close Window button closes the Connection Status screen.

IP Address. The IP address that is assigned to the router.

Subnet Mask. The subnet mask that is assigned to the router.

Default Gateway. The IP address for the default gateway that the router communicates with.

DHCP Server. The IP address for the Dynamic Host Configuration Protocol server that provides the TCP/IP configuration for all the computers that are connected to the router.

DNS Server. The IP address of the Domain Name Service server that provides translation of network names to IP addresses.

Lease Obtained. The date and time when the lease was obtained.

Lease Expires. The date and time that the lease expires.

Wireless AP

Wireless AP	
Wireless Network Name (SSID)	NETGEAR12
Region	Europe
Wireless Channel	Auto(1)
Mode	Up to 65Mbps
Wireless Radio	Enabled
Broadcast Name	on
Wireless Isolation	off
Wi-Fi Protected Setup	on

The information here is based on the fields in the Wireless Settings screen. The following settings are displayed:

Wireless Network Name (SSID). The wireless network name (SSID) used by the router.

Region. The geographic region where the router is being used. It might be illegal to use the wireless features of the router in some parts of the world.

Wireless Channel. The operating channel that the wireless port is using. The default channel is Auto. When Auto is selected, the router finds the best operating channel available. If you notice interference from nearby devices, you can select a different channel. Channels 1, 6, and 11 do not interfere with each other.

Mode. The wireless communication mode: Up to 54 Mbps, Up to 65 Mbps (default), and Up to 150 Mbps.

Wireless Radio. The status of the wireless radio that the router uses for wireless communication. If the wireless radio is disabled the Wireless LED on the front panel is off, and no one can join the wireless network.

Broadcast Name. Indicates whether the router is broadcasting its SSID.

Wireless Isolation. Wireless isolation prevents wireless clients from communicating with each other when they join the wireless network.

Wi-Fi Protected Setup. Indicates whether Wi-Fi Protected Setup is configured for this network.

View Logs of Web Access or Attempted Web Access

The log is a detailed record of the websites you have accessed or attempted to access. Up to 256 entries are stored in the log. Log entries appear only when keyword blocking is enabled and no log entries are made for the trusted user.

➤ To view logs:

Select **Advanced > Administration > Logs**. The Logs screen displays.



The log screen shows the following information:

- **Date and time.** The date and time the log entry was recorded.
- **Source IP.** The IP address of the initiating device for this log entry.
- **Target address.** The name or IP address of the website or news group visited or to which access was attempted.
- **Action.** Whether the access was blocked or allowed.

To refresh the log screen, click the **Refresh** button.

To clear the log entries, click the **Clear Log** button.

To email the log immediately, click the **Send Log** button.

Manage the Configuration File

The configuration settings of the N150 2-Port Wireless Router are stored within the router in a configuration file. You can back up (save) this file to your computer, restore it, or reset it to the factory default settings.

Back Up Settings

➤ **To back up the router's configuration settings:**

1. Select **Advanced > Administration > Backup Settings** to display the following screen:

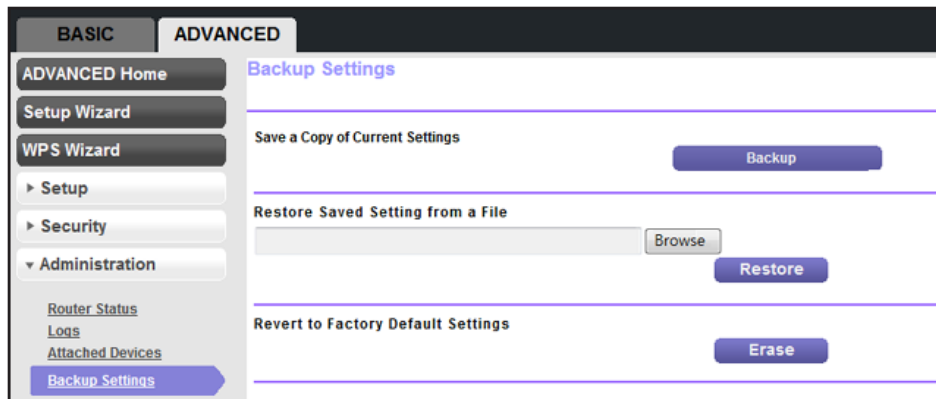

2. Click **Back Up** to save a copy of the current settings.
3. Choose a location to store the .cfg file that is on a computer on your network.

Restore Configuration Settings

➤ **To restore configuration settings that you backed up:**

1. Enter the full path to the file on your network or click the **Browse** button to find the file.
2. When you have located the .cfg file, click the **Restore** button to upload the file to the router.

Upon completion, the router reboots.



WARNING!

Do not interrupt the reboot process.

Erase

You can erase the configuration and restore the factory default settings. Some examples are if you move the router to a different network or if you have forgotten the password.

You can use the Restore Factory Settings button on the back of the router (see [Factory Settings](#) on page 89), or you can click the **Erase** button in this screen.

Erase sets the user name to admin, the password to password, and the LAN IP address to 192.168.1.1, and enables the router's DHCP.

Set Password

This feature lets you change the default password that is used to log in to the router with the user name **admin**.

This is not the same as changing the password for wireless access. The label on the bottom of your router shows your unique wireless network name (SSID) and password for wireless access (see [Label](#) on page 10).

➤ **To set the password for the user name admin:**

1. Select **Advanced > Administration > Set Password** to display the following screen:

The screenshot shows the 'Set Password' configuration page. On the left is a navigation sidebar with 'Administration' expanded and 'Set Password' selected. The main area has a title 'Set Password' and two buttons: 'Cancel' and 'Apply'. Below the title are three text input fields labeled 'Old Password', 'Set Password', and 'Repeat New Password'.

2. On the Set Password screen, type the old password, and type the new password twice.

3. Click **Apply** so that your changes take effect.

7 Advanced Settings

7

This chapter describes the advanced features of your router. The information is for readers with advanced networking knowledge who want to set the router up for unique situations such as when remote access from the Internet by IP or domain name is needed.

This chapter includes the following sections:

- *Advanced Wireless Settings*
- *Wireless Repeating Function (WDS)*
- *Port Forwarding and Triggering*
- *Set Up Port Forwarding to Local Servers*
- *Set Up Port Triggering*
- *Dynamic DNS*
- *Static Routes*
- *Remote Management*
- *Universal Plug and Play*
- *Traffic Meter*

Advanced Wireless Settings

- To go to the Advanced Wireless Settings screen:

Select **Advanced > Advanced Setup > Wireless Settings** to display the following screen:

The following settings are available in this screen:

Enable Wireless Router Radio. You can completely turn off the wireless portion of the wireless router by clearing this check box. Select this check box again to enable the wireless portion of the router. When the wireless radio is disabled, other members of your household can use the router by connecting their computers to the router with an Ethernet cable.

Enable 20/40 MHz Coexistence. By default, this check box is selected so that your wireless network does not interfere with other wireless networks in your area. This might reduce the maximum speed of your 2.4GHz wireless to the half when there is another wireless network detected in your environment. If you want to maintain maximum speed for your wireless network regardless of other networks in your area, clear this check box and click **Apply**.

Note: The Fragmentation Length, CTS/RTS Threshold, and Preamble Mode options are reserved for wireless testing and advanced configuration only. Do not change these settings.

WPS Settings. You can add WPS devices to your network.

- **Disable Router's PIN.** The router's PIN lets you use the WPS PIN method to join the wireless network. Selecting this check box disables the PIN, which means the WPS PIN method cannot be used.
- **Keep Existing Wireless Settings.** By default this check box is selected so that when WPS is used to join the wireless network, the router wireless settings do not change.

Wireless Card Access List. You can restrict access to your network to specific devices based on their MAC address. See [Restrict Wireless Access by MAC Address](#) on page 61

Restrict Wireless Access by MAC Address

You can set up a list of computers and wireless devices that are allowed to join the wireless network. This list is based on the unique MAC address of each computer and device.

Each network device has a MAC address, which is a unique 12-character physical address, containing the hexadecimal characters 0–9, a–f, or A–F only, and separated by colons (for example, 00:09:AB:CD:EF:01). Typically, the MAC address is on the label of the wireless card or network interface device. If you do not have access to the label, you can display the MAC address using the network configuration utilities of the computer. You might also find the MAC addresses in the Attached Devices screen.

➤ **To restrict access based on MAC addresses:**

1. Select **Advanced > Advanced Setup > Wireless Settings** and click the **Setup Access List** to display the Wireless Card Access List.



2. Click **Add** to add a wireless device to the wireless access control list.

The Wireless Card Access Setup screen opens and displays a list of currently active wireless cards and their Ethernet MAC addresses.

3. If the computer or device you want is in the Available Wireless Cards list, select that radio button; otherwise, type a name and the MAC address. You can usually find the MAC address on the bottom of the wireless device.

Tip: You can copy and paste the MAC addresses from the Attached Devices screen into the MAC Address field of this screen. To do this, use each wireless computer to join the wireless network. The computer should then appear in the Attached Devices screen.

4. Click **Add** to add this wireless device to the Wireless Card Access List. The screen changes back to the list screen.
5. Add each computer or device you want to allow to connect wirelessly.
6. Select the **Turn Access Control On** check box.
7. Click **Apply**.

Wireless Repeating Function (WDS)

You can set the router up to be used as a wireless access point (AP). Doing this enables the router to act as a wireless repeater. A wireless repeater connects to another wireless router as a client where the network to which it connects becomes the ISP service.

Wireless repeating is a type of Wireless Distribution System (WDS). A WDS allows a wireless network to be expanded through multiple access points instead of using a wired backbone to link them. The following figure shows a wireless repeating scenario.

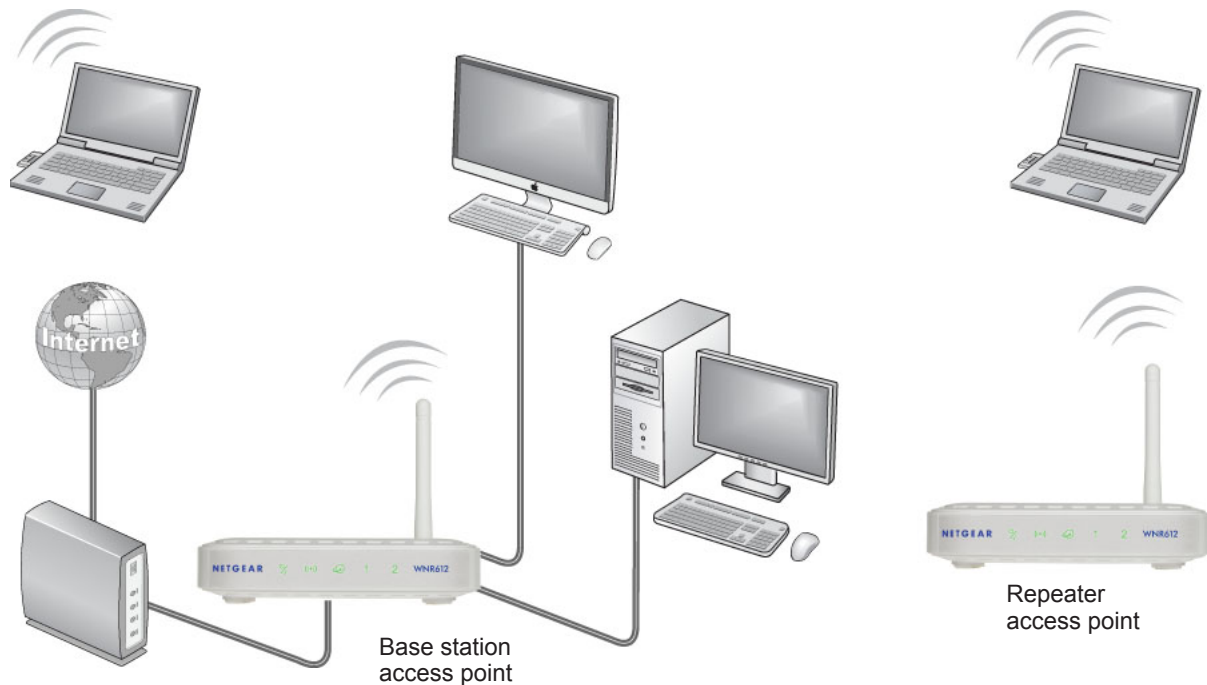

Figure 6. Wireless repeating scenario

Note: If you use the wireless repeating function, you need to select either WEP or None as a security option in the Wireless Settings screen. The WEP option displays only if you select the wireless mode Up to 54 Mbps in the Wireless Settings screen.

Wireless Base Station. The router acts as the parent access point that bridges traffic to and from the child repeater access point. The base station also handles wireless and wired local computers. To configure this mode, you have to know the MAC addresses of the child repeater access point. Often, the MAC address is on the product label.

Wireless Repeater. The router sends all traffic from its local wireless or wired computers to a remote access point. To configure this mode, you have to know the MAC address of the remote parent access point.

The WNR612v3 router is always in dual band concurrent mode, unless you turn off one radio. If you enable the wireless repeater in either radio band, the wireless base station or wireless repeater cannot be enabled in the other radio band. However, if you enable the wireless base station in either radio band and use the other radio band as a wireless router or wireless base station, dual band concurrent mode is not affected.

To set up a wireless network with WDS, both access points have to meet the following conditions:

- Both access points have to use the same SSID, wireless channel, and encryption mode.
- Both access points have to be on the same LAN IP subnet. That is, all of the access point LAN IP addresses are in the same network.
- All LAN devices (wired and wireless computers) are configured to operate in the same LAN network address range as the access points.

Wireless Repeating Function

- To view or change the wireless repeater settings for the router:

Select **Advanced > Advanced Setup > Wireless Repeating**.

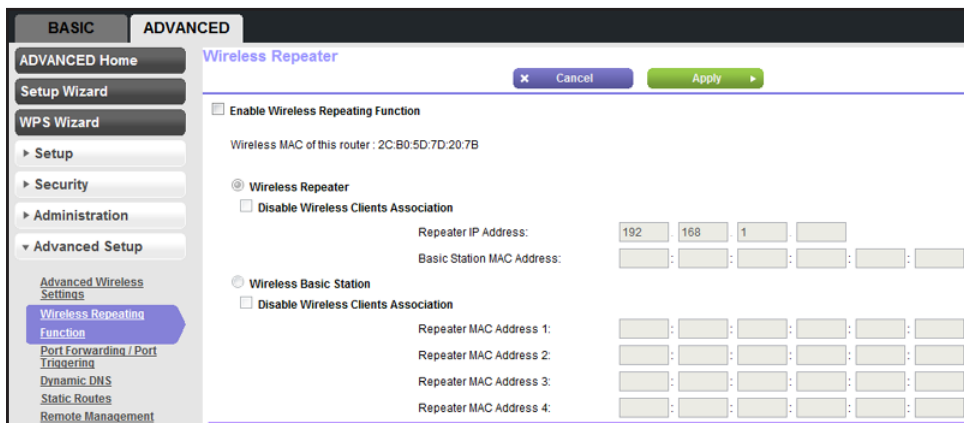

The following settings are available:

- **Enable Wireless Repeating Function.** Select the check box for the to use the wireless repeating function.
- **Wireless MAC of this router.** This field displays the MAC address for your router for your reference. You will need to enter this MAC address in the corresponding Wireless Repeating Function screen of the other access point you are using.
- **Wireless Repeater.** If your router is the repeater, select this check box.

Repeater IP Address. If your router is the repeater, enter the IP address of the other access point.

Disable Wireless Client Association. If your router is the repeater, selecting this check box means that wireless clients cannot associate with it. Only LAN client associations are allowed.

- If you are setting up a point-to-point bridge, select this check box.
- If you want all client traffic to go through the other access point (repeater with wireless client association), leave this check box cleared.

Base Station MAC Address. If your router is the repeater, enter the MAC address for the access point that is the base station.

- **Wireless Base Station.** If your router is the base station, select this check box.

Disable Wireless Client Association. If your router is the base station, selecting this check box means that wireless clients cannot associate with it. Only LAN client associations are allowed.

Repeater MAC Address (1 through 4). If your router is the base station, it can act as the “parent” of up to 4 other access points. Enter the MAC addresses of the other access points in these fields.

Set Up the Base Station

The wireless repeating function works only in hub and spoke mode. The units cannot be daisy-chained. You have to know the wireless settings for both units. You have to know the MAC address of the remote unit. First, set up the base station, and then set up the repeater.

➤ To set up the base station:

1. Set up both units with the same wireless settings (SSID, mode, channel, and security). The wireless security option has to be set to None or WEP.
2. Select **Advanced > Advanced Setup > Wireless Repeating Function** to display the Wireless Repeating Function screen.

3. In the Wireless Repeating Function screen, select the **Enable Wireless Repeating Function** check box.
4. Select the **Wireless Base Station** radio button.
5. Enter the MAC address for one or more repeater units.
6. Click **Apply** to save your changes.

Set Up a Repeater Unit

Use a wired Ethernet connection to set up the repeater unit to avoid conflicts with the wireless connection to the base station.

Note: If you are using the WNR612v3 base station with a non-router as the repeater, you might need to change additional configuration settings. In particular, you should disable the DHCP server function on the wireless repeater AP.

➤ **To configure the router as a repeater unit:**

1. Log in to the router that will be the repeater. Select **Basic > Wireless Settings** and verify that the wireless settings match the base unit exactly. The wireless security option has to be set to **WEP** or **None**.
2. Select **Advanced > Wireless Repeating Function**
3. Select the **Enable Wireless Repeating Function** check box
4. Select the **Wireless Repeater** radio button.
5. Fill in the Repeater IP Address field. This IP address has to be in the same subnet as the base station, but different from the LAN IP address of the base station.
6. Click **Apply** to save your changes.
7. Verify connectivity across the LANs.

A computer on any wireless or wired LAN segment of the router should be able to connect to the Internet or share files and printers with any other wireless or wired computer or server connected to the other access point.

Port Forwarding and Triggering

By default, the router blocks inbound traffic from the Internet to your computers except replies to your outbound traffic. You might need to create exceptions to this rule for these purposes:

- To allow remote computers on the Internet to access a server on your local network.
- To allow certain applications and games to work correctly when your router does not recognize their replies.

Your router provides two features for creating these exceptions: port forwarding and port triggering. The next sections provide background information to help you understand how port forwarding and port triggering work, and the differences between the two.

Remote Computer Access Basics

When a computer on your network needs to access a computer on the Internet, your computer sends your router a message that contains the source and destination address and

process information. Before forwarding your message to the remote computer, your router has to modify the source information and create and track the communication session so that replies can be routed back to your computer.

Here is an example of normal outbound traffic and the resulting inbound responses:

1. You open a browser and your operating system assigns port number 5678 to this browser session.
2. You type `http://www.example.com` into the URL field and your computer creates a web page request message with the following address and port information. The request message is sent to your router.

Source address. Your computer's IP address.

Source port number. 5678, which is the browser session.

Destination address. The IP address of `www.example.com`, which your computer finds by asking a DNS server.

Destination port number. 80, which is the standard port number for a web server process.

3. Your router creates an entry in its internal session table describing this communication session between your computer and the web server at `www.example.com`. Before sending the web page request message to `www.example.com`, your router stores the original information and then modifies the source information in the request message, performing Network Address Translation (NAT):
 - The source address is replaced with your router's public IP address. This is necessary because your computer uses a private IP address that is not globally unique and cannot be used on the Internet.
 - The source port number is changed to a number assigned by the router, such as 33333. This is necessary because two computers could independently use the same session number.

Your router then sends this request message through the Internet to the web server at `www.example.com`.

4. The web server at `www.example.com` composes a return message with the requested web page data. The return message contains the following address and port information. The web server then sends this reply message to your router.

Source address. The IP address of `www.example.com`.

Source port number. 80, which is the standard port number for a web server process.

Destination address. The public IP address of your router.

Destination port number. 33333.

5. Upon receiving the incoming message, your router checks its session table to determine whether there is an active session for port number 33333. Finding an active session, the router then modifies the message to restore the original address information replaced by NAT. Your router sends this reply message to your computer, which displays the web page from `www.example.com`. The message now contains the following address and port information.

Source address. The IP address of www.example.com.

Source port number. 80, which is the standard port number for a web server process.

Destination address. Your computer's IP address.

Destination port number. 5678, which is the browser session that made the initial request.

6. When you finish your browser session, your router eventually detects a period of inactivity in the communications. Your router then removes the session information from its session table and incoming traffic is no longer accepted on port number 33333.

Port Triggering to Open Incoming Ports

In the preceding example, requests are sent to a remote computer by your router from a particular service port number. Replies from the remote computer to your router are directed to that port number. If the remote server sends a reply to a different port number, your router does not recognize it and discards it. However, some application servers (such as FTP and IRC servers) send replies to multiple port numbers. Using the port triggering function of your router, you can tell the router to open additional incoming ports when a particular outgoing port originates a session.

An example is Internet Relay Chat (IRC). Your computer connects to an IRC server at destination port 6667. The IRC server not only responds to your originating source port, but also sends an "identify" message to your computer on port 113. Using port triggering, you can tell the router, "When you initiate a session with destination port 6667, you have to also allow incoming traffic on port 113 to reach the originating computer." Using steps similar to the preceding example, the following sequence shows the effects of the port triggering rule you have defined:

1. You open an IRC client program to start a chat session on your computer.
2. Your IRC client composes a request message to an IRC server using a destination port number of 6667, which is the standard port number for an IRC server process. Your computer then sends this request message to your router.
3. Your router creates an entry in its internal session table describing this communication session between your computer and the IRC server. Your router stores the original information, performs Network Address Translation (NAT) on the source address and port, and sends this request message through the Internet to the IRC server.
4. Noting your port triggering rule and having observed the destination port number of 6667, your router creates an additional session entry to send any incoming port 113 traffic to your computer.
5. The IRC server sends a return message to your router using the NAT-assigned source port (as in the previous example, say port 33333) as the destination port. The IRC server also sends an "identify" message to your router with destination port 113.
6. Upon receiving the incoming message to destination port 33333, your router checks its session table to determine whether there is an active session for port number 33333. Finding an active session, the router restores the original address information replaced by NAT and sends this reply message to your computer.

7. Upon receiving the incoming message to destination port 113, your router checks its session table and learns that there is an active session for port 113, associated with your computer. The router replaces the message's destination IP address with your computer's IP address and forwards the message to your computer.
8. When you finish your chat session, your router eventually senses a period of inactivity in the communications. The router then removes the session information from its session table, and incoming traffic is no longer accepted on port numbers 33333 or 113.

To configure port triggering, you need to know which inbound ports the application needs. Also, you need to know the number of the outbound port that will trigger the opening of the inbound ports. You can usually determine this information by contacting the publisher of the application or user groups or newsgroups.

Note: Only one computer at a time can use the triggered application.

Port Forwarding to Permit External Host Communications

In both of the preceding examples, your computer initiates an application session with a server computer on the Internet. However, you might need to allow a client computer on the Internet to initiate a connection to a server computer on your network. Normally, your router ignores any inbound traffic that is not a response to your own outbound traffic. You can configure exceptions to this default rule by using the port forwarding feature.

A typical application of port forwarding can be shown by reversing the client-server relationship from the previous web server example. In this case, a remote computer's browser needs to access a web server running on a computer in your local network. Using port forwarding, you can tell the router, "When you receive incoming traffic on port 80 (the standard port number for a web server process), forward it to the local computer at 192.168.1.123." The following sequence shows the effects of the port forwarding rule you have defined:

1. The user of a remote computer opens a browser and requests a web page from `www.example.com`, which resolves to the public IP address of your router. The remote computer composes a web page request message with the following destination information:

Destination address. The IP address of `www.example.com`, which is the address of your router.

Destination port number. 80, which is the standard port number for a web server process.

The remote computer then sends this request message through the Internet to your router.

2. Your router receives the request message and looks in its rules table for any rules covering the disposition of incoming port 80 traffic. Your port forwarding rule specifies that incoming port 80 traffic should be forwarded to local IP address 192.168.1.123. Therefore, your router modifies the destination information in the request message:

The destination address is replaced with 192.168.1.123.

Your router then sends this request message to your local network.

3. Your web server at 192.168.1.123 receives the request and composes a return message with the requested web page data. Your web server then sends this reply message to your router.
4. Your router performs NAT on the source IP address, and sends this request message through the Internet to the remote computer, which displays the web page from www.example.com.

To configure port forwarding, you need to know which inbound ports the application needs. You usually can determine this information by contacting the publisher of the application or the relevant user groups and newsgroups.

How Port Forwarding Differs from Port Triggering

The following points summarize the differences between port forwarding and port triggering:

- Port triggering can be used by any computer on your network, although only one computer can use it at a time.
- Port forwarding is configured for a single computer on your network.
- Port triggering does require that you know the computer's IP address in advance. The IP address is captured automatically.
- Port forwarding requires that you specify the computer's IP address during configuration, and the IP address can never change.
- Port triggering requires specific outbound traffic to open the inbound ports, and the triggered ports are closed after a period of no activity.
- Port forwarding is always active and does not need to be triggered.

Set Up Port Forwarding to Local Servers

The port forwarding feature lets you allow certain types of incoming traffic to reach servers on your local network. For example, you might want to make a local web server, FTP server, or game server visible and available to the Internet.

Use the Port Forwarding screen to configure the router to forward specific incoming protocols to computers on your local network. In addition to servers for specific applications, you can also specify a default DMZ server to which all other incoming protocols are forwarded.

Before starting, determine which type of service, application, or game you want to provide. Find out the local IP address of the computer that will provide the service. The server computer has to always have the same IP address.

➤ **To set up port forwarding:**

Tip: To ensure that your server computer always has the same IP address, use the reserved IP address feature of your router. See [Address Reservation](#) on page 39.

1. Select Advanced Setup > Port Forwarding/Port Triggering:

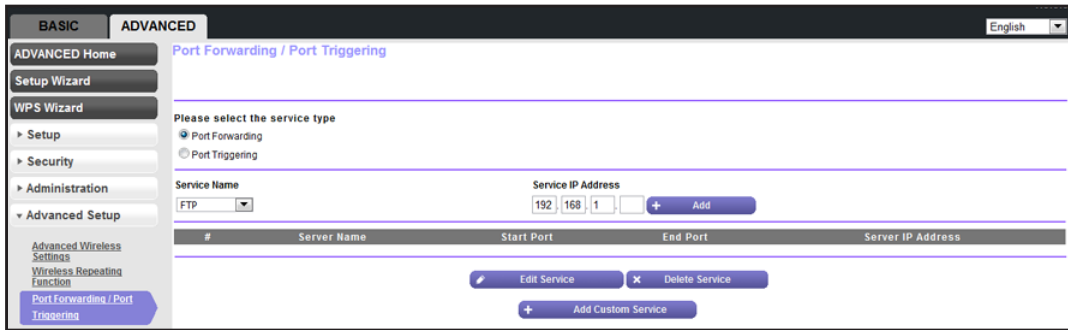

Port Forwarding is selected as the service type.

2. From the Service Name list, select the service or game that you will host on your network. If the service does not appear in the list, see [Add a Custom Service](#) on page 70.
3. In the corresponding Server IP Address field, enter the last digit of the IP address of your local computer that will provide this service.
4. Click **Add**. The service appears in the list in the screen.

Add a Custom Service

To define a service, game, or application that does not appear in the Service Name list, first determine which port number or range of numbers the application uses. You can usually get this information by contacting the publisher of the application or user groups or newsgroups.

➤ **To add a custom service:**

1. Select **Advanced > Advanced Setup > Port Forwarding/Port Triggering**.
2. Select **Port Forwarding** as the service type.
3. Click the **Add Custom Service** button to display the following screen:

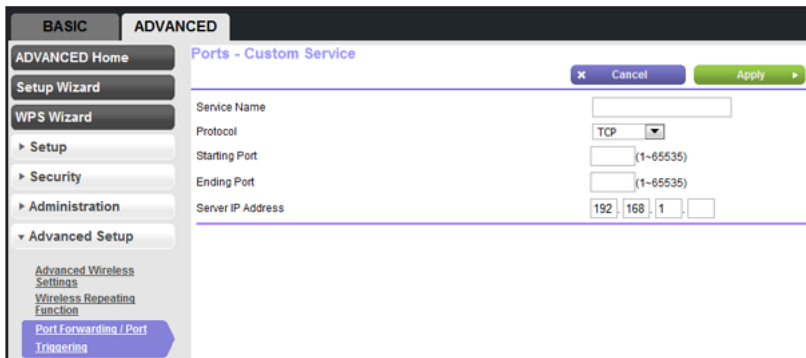

4. In the Service Name field, enter a descriptive name.
5. In the Protocol list, select the protocol. If you are unsure, select **TCP/UDP**.
6. In the Starting Port field, enter the beginning port number.
 - If the application uses a single port, enter the same port number in the Ending Port field.
 - If the application uses a range of ports, enter the ending port number of the range in the Ending Port field.
7. In the Server IP Address field, enter the IP address of your local computer that will provide this service.
8. Click **Apply**. The service appears in the list in the Port Forwarding/Port Triggering screen.

Edit or Delete a Port Forwarding Entry

➤ To edit or delete a port forwarding entry:

1. In the table, select the radio button next to the service name.
2. Click **Edit Service** or **Delete Service**.

Application Example: Making a Local Web Server Public

If you host a web server on your local network, you can use port forwarding to allow web requests from anyone on the Internet to reach your web server.

➤ To make a local web server public:

1. Assign your web server either a fixed IP address or a dynamic IP address using DHCP address reservation. In this example, your router always gives your web server an IP address of 192.168.1.33.
2. In the Port Forwarding screen, configure the router to forward the HTTP service to the local address of your web server at **192.168.1.33**. HTTP (port 80) is the standard protocol for web servers.
3. (Optional) Register a host name with a Dynamic DNS service, and configure your router to use the name as described in *Dynamic DNS* on page 73. To access your web server from the Internet, a remote user has to know the IP address that your ISP assigned. However, if you use a Dynamic DNS service, the remote user can reach your server by a user-friendly Internet name, such as mynetgear.dyndns.org.

Set Up Port Triggering

Port triggering is a dynamic extension of port forwarding that is useful in these cases:

- More than one local computer needs port forwarding for the same application (but not simultaneously).
- An application needs to open incoming ports that are different from the outgoing port.

When port triggering is enabled, the router monitors outbound traffic looking for a specified outbound “trigger” port. When the router detects outbound traffic on that port, it remembers

the IP address of the local computer that sent the data. The router then temporarily opens the specified incoming port or ports, and forwards incoming traffic on the triggered ports to the triggering computer.

Port forwarding creates a static mapping of a port number or range to a single local computer. Port triggering can dynamically open ports to any computer that needs them and can close the ports when they are no longer needed.

Note: If you use applications such as multiplayer gaming, peer-to-peer connections, real-time communications such as instant messaging, or remote assistance (a feature in Windows XP), you should also enable Universal Plug and Play (UPnP) according to the instructions in *Universal Plug and Play* on page 77.

To set up port triggering, you need to know which inbound ports the application needs and the number of the outbound port that will trigger the opening of the inbound ports. You can usually get this information by contacting the publisher of the application or user groups or newsgroups.

➤ **To set up port triggering:**

1. Select **Advanced > Advanced Setup > Port Forwarding/Port Triggering**.
2. Select the **Port Triggering** radio button to display the port triggering information.

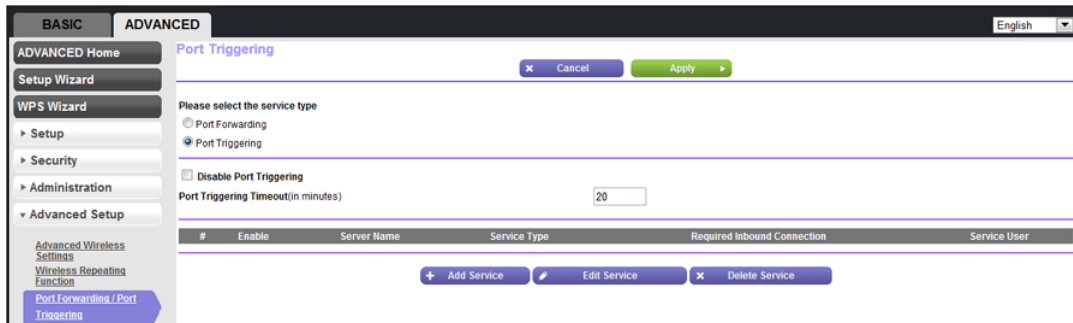

3. Clear the **Disable Port Triggering** check box if it is selected.

Note: If the *Disable Port Triggering* check box is selected after you configure port triggering, port triggering is disabled. However, any port triggering configuration information you added to the router is retained even though it is not used.

4. In the Port Triggering Timeout field, enter a value up to 9999 minutes.
5. This value controls the inactivity timer for the designated inbound ports. The inbound ports close when the inactivity time expires. This is required because the router cannot be sure when the application has terminated.

6. Click **Add Service** to display the following screen:

7. In the Service Name field, type a descriptive service name.
8. In the Service User list, select **Any** (the default) to allow this service to be used by any computer on the Internet. Otherwise, select **Single address**, and enter the IP address of one computer to restrict the service to a particular computer.
9. Select the service type, either **TCP** or **UDP** or both (**TCP/UDP**). If you are not sure, select TCP/UDP.
10. In the Triggering Port field, enter the number of the outbound traffic port that will cause the inbound ports to be opened.
11. Enter the inbound connection port information in the Connection Type, Starting Port, and Ending Port fields.
12. Click **Apply**. The service appears in the Port Triggering Portmap table.

Dynamic DNS

If your Internet service provider (ISP) gave you a permanently assigned IP address, you can register a domain name and have that name linked with your IP address by public Domain Name Servers (DNS). However, if your Internet account uses a dynamically assigned IP address, you do not know in advance what your IP address will be, and the address can change frequently. In this case, you can use a commercial Dynamic DNS service. This type of service lets you register your domain to their IP address and forwards traffic directed at your domain to your frequently changing IP address.

If your ISP assigns a private WAN IP address (such as 192.168.x.x or 10.x.x.x), the Dynamic DNS service does not work because private addresses are not routed on the Internet.

Your router contains a client that can connect to the Dynamic DNS service provided by DynDNS.org. First visit their website at <http://www.dyndns.org> and obtain an account and host name that you configure in the router. Then, whenever your ISP-assigned IP address changes, your router automatically contacts the Dynamic DNS service provider, logs in to your account, and registers your new IP address. If your host name is hostname, for example, you can reach your router at <http://hostname.dyndns.org>.

➤ **To set up Dynamic DNS:**

1. On the Advanced tab, select **Advanced Setup > Dynamic DNS** to display the following screen:

2. Register for an account with one of the Dynamic DNS service providers whose names appear in the Service Provider list. For example, for DynDNS.org, select www.dyndns.org.
3. Select the **Use a Dynamic DNS Service** check box.
4. Select the name of your Dynamic DNS service provider.
5. Type the host name (or domain name) that your Dynamic DNS service provider gave you.
6. Type the user name for your Dynamic DNS account. This is the name that you use to log in to your account, not your host name.
7. Type the password (or key) for your Dynamic DNS account.
8. If your Dynamic DNS provider allows the use of wildcards in resolving your URL, you can select the **Use Wildcards** check box to activate this feature.

For example, the wildcard feature causes `*.yourhost.dyndns.org` to be aliased to the same IP address as `yourhost.dyndns.org`.

9. Click **Apply** to save your configuration.

Static Routes

Static routes provide additional routing information to your router. Typically, you do not need to add static routes. You have to configure static routes only for unusual cases such as multiple routers or multiple IP subnets on your network.

As an example of when a static route is needed, consider the following case:

- Your primary Internet access is through a cable modem to an ISP.
- You have an ISDN router on your home network for connecting to the company where you are employed. This router's address on your LAN is 192.168.1.100.
- Your company's network address is 134.177.0.0.

When you first configured your router, two implicit static routes were created. A default route was created with your ISP as the gateway, and a second static route was created to your local network for all 192.168.1.x addresses. With this configuration, if you attempt to access a device on the 134.177.0.0 network, your router forwards your request to the ISP. The ISP

forwards your request to the company where you are employed, and the request is likely to be denied by the company's firewall.

In this case you have to define a static route, telling your router that 134.177.0.0 should be accessed through the ISDN router at 192.168.1.100. In this example:

- The Destination IP Address and IP Subnet Mask fields specify that this static route applies to all 134.177.x.x addresses.
- The Gateway IP Address field specifies that all traffic for these addresses should be forwarded to the ISDN router at 192.168.1.100.
- A metric value of 1 will work since the ISDN router is on the LAN.
- Private is selected only as a precautionary security measure in case RIP is activated.

➤ **To set up a static route:**

1. Select **Advanced > Advanced Setup > Static Routes**
2. Click **Add** to display the following screen:

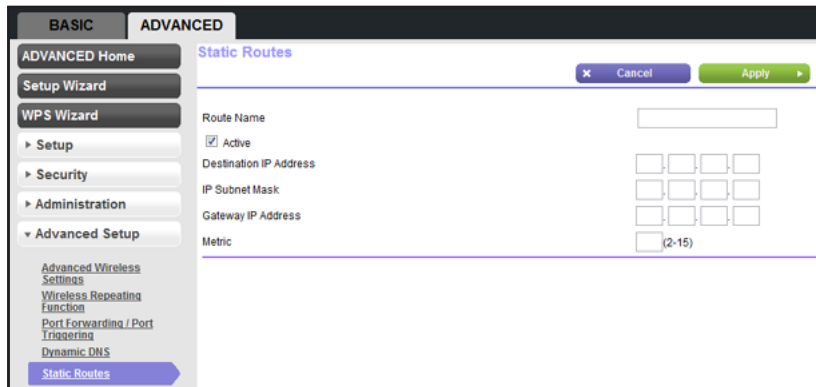

3. In the Route Name field, type a name for this static route (for identification purposes only.)
4. Select the **Private** check box if you want to limit access to the LAN only. If Private is selected, the static route is not reported in RIP.
5. Select the **Active** check box to make this route effective.
6. Type the destination IP address of the final destination.
7. Type the IP subnet mask for this destination. If the destination is a single host, type **255.255.255.255**.
8. Type the gateway IP address, which has to be a router on the same LAN segment as the N150 2-Port Wireless Router.
9. Type a number from 1 through 15 as the metric value.

This value represents the number of routers between your network and the destination. Usually, a setting of 2 or 3 works, but if this is a direct connection, set it to 1.

10. Click **Apply** to add the static route.

Remote Management

The remote management feature lets you upgrade or check the status of your N150 2-Port Wireless Router over the Internet.

➤ **To set up remote management:**

1. Select **Advanced > Advanced Setup > Remote Management**.

Note: Be sure to change the router's default login password to a secure password. The ideal password contains no dictionary words from any language and contains uppercase and lowercase letters, numbers, and symbols. It can be up to 30 characters.

2. Select the **Turn Remote Management On** check box.
3. Under **Allow Remote Access By**, specify the external IP addresses to be allowed to access the router's remote management.

Note: For enhanced security, restrict access to as few external IP addresses as practical.

- To allow access from a single IP address on the Internet, select **Only This Computer**. Enter the IP address that will be allowed access.
 - To allow access from a range of IP addresses on the Internet, select **IP Address Range**. Enter a beginning and ending IP address to define the allowed range.
 - To allow access from any IP address on the Internet, select **Everyone**.
4. Specify the port number for accessing the management interface.

Normal web browser access uses the standard HTTP service port 80. For greater security, enter a custom port number for the remote web management interface. Choose a number from 1024 to 65535, but do not use the number of any common service port. The default is 8080, which is a common alternate for HTTP.

5. Click **Apply** so that your changes take effect.
6. When you access your router from the Internet, type your router's WAN IP address into your browser's address or location field followed by a colon (:) and the custom port number. For example, if your external address is 134.177.0.123 and you use port number 8080, enter **http://134.177.0.123:8080** in your browser.

Universal Plug and Play

Universal Plug and Play (UPnP) helps devices, such as Internet appliances and computers, access the network and connect to other devices as needed. UPnP devices can automatically discover the services from other registered UPnP devices on the network.

If you use applications such as multiplayer gaming, peer-to-peer connections, or real-time communications such as instant messaging or remote assistance (a feature in Windows XP), you should enable UPnP.

➤ To turn on Universal Plug and Play:

1. Select **Advanced > Advanced Setup > UPnP**. The UPnP screen displays.

Active	Protocol	Int. Port	Ext. Port	IP Address	Description

2. Adjust the following settings as needed:

Turn UPnP On. UPnP can be enabled or disabled for automatic device configuration. The default setting for UPnP is disabled. If this check box is not selected, the router does not allow any device to automatically control the resources, such as port forwarding (mapping) of the router.

Advertisement Period. The advertisement period is how often the router broadcasts its UPnP information. This value can range from 1 to 1440 minutes. The default period is 30 minutes. Shorter durations ensure that control points have current device status at the expense of additional network traffic. Longer durations can compromise the freshness of the device status, but can significantly reduce network traffic.

Advertisement Time to Live. The time to live for the advertisement is measured in hops (steps) for each UPnP packet sent. The time to live hop count is the number of steps a broadcast packet is allowed to propagate for each UPnP advertisement before it disappears. The number of hops can range from 1 to 255. The default value for the

advertisement time to live is 4 hops, which is fine for most home networks. If you notice that some devices are not being updated or reached correctly, then it might be necessary to increase this value.

UPnP Portmap Table. The UPnP Portmap Table displays the IP address of each UPnP device that is currently accessing the router and which ports (internal and external) that device has opened. The UPnP Portmap Table also displays what type of port is open and whether that port is still active for each IP address.

3. Click **Apply** to save your settings.

Traffic Meter

Traffic metering allows you to monitor the volume of Internet traffic that passes through your router's Internet port. With the Traffic Meter utility, you can set limits for traffic volume, set a monthly limit, and get a live update of traffic usage.

➤ **To monitor Internet traffic:**

1. Click **Advanced > Advanced Setup > Traffic Meter** to display the following screen:

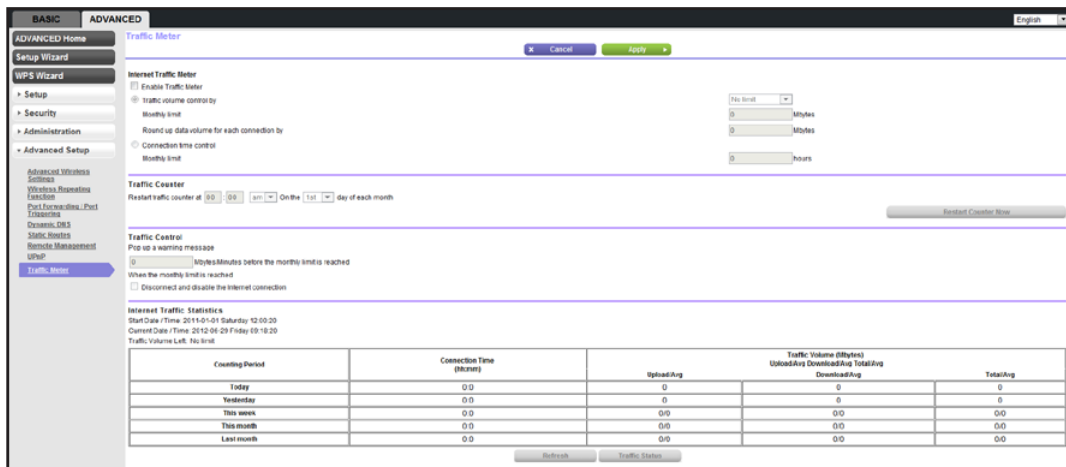

2. To enable the Traffic Meter, select the **Enable Traffic Meter** check box.
3. If you want to record and restrict the volume of Internet traffic, select the **Traffic volume control by** radio button. You can select one of the following options for controlling the traffic volume:
 - No Limit.** No restriction is applied when the traffic limit is reached.
 - Download only.** The restriction is applied to incoming traffic only.
 - Both Directions.** The restriction is applied to both incoming and outgoing traffic.
4. You can limit the amount of data traffic allowed per month by specifying how many Mbytes per month are allowed or by specifying how many hours of traffic are allowed.
5. Set the Traffic Counter to begin at a specific time and date.

6. Set up Traffic Control to issue a warning message before the monthly limit of Mbytes or hours is reached. You can select one of the following to occur when the limit is attained:
 - The Internet LED flashes green or amber.
 - The Internet connection is disconnected and disabled.
7. Set up Internet Traffic Statistics to monitor the data traffic.
8. Click the **Traffic Status** button to get a live update on Internet traffic status on your router.
9. Click **Apply** to save your settings.

8 Troubleshooting

8

This chapter provides information to help you diagnose and solve problems you might have with your router. If you do not find the solution here, check the NETGEAR support site at <http://support.netgear.com> for product and contact information.

This chapter contains the following sections:

- *Quick Tips*
- *Troubleshooting with the LEDs*
- *Cannot Log In to the Router*
- *Cannot Access the Internet*
- *Changes Not Saved*
- *Wireless Connectivity*
- *Restore the Factory Settings and Password*
- *Troubleshoot Your Network Using the Ping Utility*

Quick Tips

This section describes tips for troubleshooting some common problems.

Sequence to Restart Your Network

When you need to restart your network, follow this sequence:

1. Turn off *and* unplug the modem.
2. Turn off the router and computers.
3. Plug in the modem and turn it on. Wait 2 minutes.
4. Turn on the router and wait 2 minutes.
5. Turn on the computers.

Check Ethernet Cable Connections

If your device does not power on, make sure that the Ethernet cables are securely plugged in.

- The Internet LED on the router is on if the Ethernet cable connecting the router and the modem is plugged in securely and the modem and router are turned on.
- For each powered-on computer connected to the router by an Ethernet cable, the corresponding numbered router LAN port LED is on.

Wireless Settings

Make sure that the wireless settings in the computer and router match exactly.

- For a wirelessly connected computer, the wireless network name (SSID) and wireless security settings of the router and wireless computer need to match exactly.
- If you set up an access list in the Advanced Wireless Settings screen, you have to add each wireless computer's MAC address to the router's access list.

Network Settings

Make sure that the network settings of the computer are correct.

- Wired and wirelessly connected computers need to have network (IP) addresses on the same network as the router. The simplest way to do this, is to configure each computer to obtain an IP address automatically using DHCP.
- Some cable modem service providers require you to use the MAC address of the computer initially registered on the account. You can view the MAC address in the Attached Devices screen.

Troubleshooting with the LEDs

After you turn on power to the router, the following sequence of events should occur:

1. When power is first applied, verify that the Power/Test LED  is on.
2. Verify that the Power/Test LED starts to blink.
3. After approximately 30 seconds, verify the following:
 - The Power/Test LED is solid green.
 - The Internet LED is on.
 - A numbered Ethernet port LED is on for any local port that is connected to a computer. This indicates that a link has been established to the connected device.

The LEDs on the front panel of the router can be used for troubleshooting.

Power/Test LED Is Off or Blinking

- Make sure that the power cord is securely connected to your router and that the power adapter is securely connected to a functioning power outlet.
- Check that you are using the 5V DC, 1A power adapter that NETGEAR supplied for this product.
- If the Power/Test LED blinks slowly and continuously, the router firmware is corrupted. This can happen if a firmware upgrade is interrupted, or if the router detects a problem with the firmware. If the error persists, you have a hardware problem. For recovery instructions, or help with a hardware problem, contact technical support at www.netgear.com/support.

Internet or Ethernet Port LEDs Are Off

If either the Ethernet port LEDs or the Internet LED does not light when the Ethernet connection is made, check the following:

- Make sure that the Ethernet cable connections are secure at the router and at the modem or computer.
- Make sure that power is turned on to the connected modem or computer.
- Be sure that you are using the correct cable:

When connecting the router's Internet port to a cable or DSL modem, use the cable that was supplied with the cable or DSL modem. This cable could be a standard straight-through Ethernet cable or an Ethernet crossover cable.

Wireless LED Is Off

If the Wireless LEDs stay off, check to see if the Wireless radio has been disabled in the Advanced Wireless Settings screen (*Advanced Wireless Settings* on page 60). The Wireless LED is lit when the wireless radio is turned on.

Cannot Log In to the Router

If you are unable to log in to the router from a computer on your local network, check the following:

- If you are using an Ethernet-connected computer, check the Ethernet connection between the computer and the router as described in the previous section.
- Make sure that your computer's IP address is on the same subnet as the router. If you are using the recommended addressing scheme, your computer's address should be in the range of 192.168.1.2 to 192.168.1.254.
- If your computer's IP address is shown as 169.254.x.x, recent versions of Windows and MacOS generate and assign an IP address if the computer cannot reach a DHCP server. These autogenerated addresses are in the range of 169.254.x.x. If your IP address is in this range, check the connection from the computer to the router, and reboot your computer.
- If your router's IP address was changed and you do not know the current IP address, clear the router's configuration to factory defaults. This sets the router's IP address to 192.168.1.1. This procedure is explained in *Factory Settings* on page 89.
- Make sure that your browser has Java, JavaScript, or ActiveX enabled. If you are using Internet Explorer, click **Refresh** to be sure that the Java applet is loaded.
- Try quitting the browser and launching it again.
- Make sure that you are using the correct login information. The factory default login name is **admin**, and the password is **password**. Make sure that Caps Lock is off when you enter this information.
- If you are attempting to set up your NETGEAR router as an additional router behind an existing router in your network, consider replacing the existing router. NETGEAR does not support such a configuration.
- If you are attempting to set up your NETGEAR router as a replacement for an ADSL gateway in your network, the router cannot perform many gateway services. For example, the router cannot convert ADSL or cable data into Ethernet networking information. NETGEAR does not support such a configuration.

Cannot Access the Internet

If you can access your router but not the Internet, check to see if the router can obtain an IP address from your Internet service provider (ISP). Unless your ISP provides a fixed IP address, your router requests an IP address from the ISP. You can determine whether the request was successful using the Router Status screen.

➤ **To check the WAN IP address:**

1. Start your browser, and select an external site such as www.netgear.com.
2. Access the router interface at www.routerlogin.net.
3. Select **Administration > Router Status**.
4. Check that an IP address is shown for the Internet port. If 0.0.0.0 is shown, your router has not obtained an IP address from your ISP.

If your router cannot obtain an IP address from the ISP, you might need to force your cable or DSL modem to recognize your new router by restarting your network, as described in [Sequence to Restart Your Network](#) on page 81.

If your router is still unable to obtain an IP address from the ISP, the problem might be one of the following:

- Your Internet service provider (ISP) might require a login program. Ask your ISP whether they require PPP over Ethernet (PPPoE) or some other type of login.
- If your ISP requires a login, the login name and password might be set incorrectly.
- Your ISP might check for your computer's host name. Assign the computer host name of your ISP account as the account name in the Internet Setup screen.
- Your ISP allows only one Ethernet MAC address to connect to Internet and might check for your computer's MAC address. In this case, do one of the following:
 - Inform your ISP that you have bought a new network device, and ask them to use the router's MAC address.
 - Configure your router to clone your computer's MAC address.

If your router can obtain an IP address, but your computer is unable to load any web pages from the Internet:

- Your computer might not recognize any DNS server addresses.

A DNS server is a host on the Internet that translates Internet names (such as www addresses) to numeric IP addresses. Typically, your ISP provides the addresses of one or two DNS servers for your use. If you entered a DNS address during the router's configuration, reboot your computer, and verify the DNS address. You can configure your computer manually with DNS addresses, as explained in your operating system documentation.

- Your computer might not have the router configured as its TCP/IP gateway.

If your computer obtains its information from the router by DHCP, reboot the computer, and verify the gateway address.

- You might be running login software that is no longer needed.

If your ISP provided a program to log you in to the Internet (such as WinPoET), you no longer need to run that software after installing your router. You might need to go to Internet Explorer and select **Tools > Internet Options**, click the **Connections** tab, and select **Never dial a connection**.

Troubleshooting PPPoE

If you are using PPPoE, try troubleshooting your Internet connection.

➤ **To troubleshoot a PPPoE connection:**

1. Log in to the router.
2. Select **Administration > Router Status**.
3. Click **Connection Status**. If all of the steps indicate OK, then your PPPoE connection is up and working.

If any of the steps indicate Failed, you can attempt to reconnect by clicking **Connect**. The router continues to attempt to connect indefinitely.

If you cannot connect after several minutes, you might be using an incorrect service name, user name, or password. There also might be a provisioning problem with your ISP.

Note: Unless you connect manually, the router does not authenticate using PPPoE until data is transmitted to the network.

Troubleshooting Internet Browsing

If your router can obtain an IP address but your computer is unable to load any web pages from the Internet, check the following:

- Your computer might not recognize any DNS server addresses. A DNS server is a host on the Internet that translates Internet names (such as www addresses) to numeric IP addresses.

Typically, your ISP provides the addresses of one or two DNS servers for your use. If you entered a DNS address during the router's configuration, restart your computer.

Alternatively, you can configure your computer manually with a DNS address, as explained in the documentation for your computer.

- Your computer might not have the router configured as its default gateway.

Reboot the computer and verify that the router address (www.routerlogin.net) is listed by your computer as the default gateway address.

- You might be running log in software that is no longer needed. If your ISP provided a program to log you in to the Internet (such as WinPoET), you no longer need to run that software after installing your router. You might need to go to Internet Explorer and select **Tools > Internet Options**, click the **Connections** tab, and select **Never dial a connection**.

Changes Not Saved

If the router does not save the changes you make in the router interface, check the following:

- When entering configuration settings, always click the **Apply** button before moving to another screen or tab, or your changes are lost.
- Click the **Refresh** or **Reload** button in the web browser. The changes might have occurred, but the old settings might be in the web browser's cache.

Wireless Connectivity

If you are having trouble connecting wirelessly to the router, try to isolate the problem.

- Does the wireless device or computer that you are using find your wireless network?

If not, check the WiFi LED on the front of the router. It should be lit. If it is not, someone might have turned off the wireless radio. You can go to the Advanced Wireless Settings screen and turn the wireless radio on (*Advanced Wireless Settings* on page 60).

If you disabled the router's SSID broadcast, then your wireless network is hidden and does not show up in your wireless client's scanning list. (By default, SSID broadcast is enabled.)

- Does your wireless device support the security that you are using for your wireless network (WPA or WPA2)?
- If you want to view the wireless settings for the router, use an Ethernet cable to connect a computer to a LAN port on the router. Then log in to the router, and select **Wireless** see (*Basic Wireless Settings* on page 24).

Note: Be sure to click **Apply** if you make changes.

Wireless Signal Strength

If your wireless device finds your network, but the signal strength is weak, check these conditions:

- Is your router too far from your computer, or too close? Place your computer near the router, but at least 6 feet (1.8 meters) away, and see whether the signal strength improves.
- Is your wireless signal blocked by objects between the router and your computer?

Restore the Factory Settings and Password

This section explains how to restore the factory settings, changing the router's administration password back to **password**. You can erase the current configuration and restore factory defaults in two ways:

- Use the Erase function of the router (see *Erase* on page 58).
- Use the Reset button on the back of the router. See *Factory Settings* on page 89. If you restore the factory settings and the router fails to restart, or the green Power/Test LED continues to blink, the unit might be defective. If the error persists, you might have a hardware problem and should contact technical support at <http://www.netgear.com/support>.

Troubleshoot Your Network Using the Ping Utility

Most network devices and routers contain a ping utility that sends an echo request packet to the designated device. The device then responds with an echo reply. Troubleshooting a network is made easy by using the ping utility in your computer or workstation.

Test the LAN Path to Your Router

You can ping the router from your computer to verify that the LAN path to your router is set up correctly.

➤ **To ping the router from a Windows PC:**

1. From the Windows toolbar, click **Start**, and then select **Run**.
2. In the field provided, type **ping** followed by the IP address of the router, as in this example:
ping www.routerlogin.net
3. Click **OK**.

You should see a message like this one:

```
Pinging <IP address >with 32 bytes of data
```

If the path is working, you see this message:

```
Reply from < IP address >: bytes=32 time=NN ms TTL=xxx
```

If the path is not working, you see this message:

```
Request timed out
```

If the path is not functioning correctly, you could have one of the following problems:

- Wrong physical connections

For a wired connection, make sure that the numbered LAN port LED is on for the port to which you are connected.

Check that the appropriate LEDs are on for your network devices. If your router and computer are connected to a separate Ethernet switch, make sure that the link LEDs are on for the switch ports that are connected to your computer and router.

- Wrong network configuration

Verify that the Ethernet card driver software and TCP/IP software are both installed and configured on your computer.

Verify that the IP address for your router and your computer are correct and that the addresses are on the same subnet.

Test the Path from Your Computer to a Remote Device

After verifying that the LAN path works correctly, test the path from your computer to a remote device.

1. From the Windows toolbar, click the **Start** button, and then select **Run**.
2. In the Windows Run window, type:

ping -n 10 <IP address>

where <IP address> is the IP address of a remote device such as your ISP's DNS server.

If the path is functioning correctly, replies like those shown in the previous section are displayed.

If you do not receive replies:

- Check that your computer has the IP address of your router listed as the default gateway. If the IP configuration of your computer is assigned by DHCP, this information is not visible in your computer's Network Control Panel. Verify that the IP address of the router is listed as the default gateway.
- Check to see that the network address of your computer (the portion of the IP address specified by the subnet mask) is different from the network address of the remote device.
- Check that your cable or DSL modem is connected and functioning.
- If your ISP assigned a host name to your computer, enter that host name as the account name in the Internet Setup screen.
- Your ISP could be rejecting the Ethernet MAC addresses of all but one of your computers.

Many broadband ISPs restrict access by allowing traffic only from the MAC address of your broadband modem. Some ISPs additionally restrict access to the MAC address of a single computer connected to that modem. If this is the case, configure your router to "clone" or "spoof" the MAC address from the authorized computer.

Supplemental Information



This appendix provides factory default settings and technical specifications for the N150 2-Port Wireless Router WNR612v3.

Factory Settings

You can return the router to its factory settings. Use the end of a paper clip or a similar object to press and hold the **Reset** button on the back of the router for at least 7 seconds. The router resets, and returns to the factory configuration settings shown in the following table.

Table 3. Factory default settings

Feature		Default behavior
Router login	User login URL	www.routerlogin.com or www.routerlogin.net
	User name (case-sensitive)	admin
	Login password (case-sensitive)	password
Internet connection	WAN MAC address	Use default hardware address
	WAN MTU size	1500
	Port speed	AutoSensing
Local network (LAN)	LAN IP	192.168.1.1
	Subnet mask	255.255.255.0
	DHCP server	Enabled
	DHCP range	192.168.1.2 to 192.168.1.254
	Time zone	GMT
	Time zone daylight savings time	Disabled
	Allow a registrar to configure this router	Enabled
DMZ	Disabled	

Table 3. Factory default settings (Continued)

Feature		Default behavior
Wireless	Wireless communication	Enabled
	SSID name	See router label
	Security	WPA2-PSK (AES)
	Broadcast SSID	Enabled
	Transmission speed	Auto*
	Country/region	United States in the US; otherwise varies by region
	RF channel	6 until region selected
	Operating mode	Up to 150 Mbps
Firewall	Inbound (communications coming in from the Internet)	Disabled (bars all unsolicited requests)
	Outbound (communications going out to the Internet)	Enabled (all)

*. Maximum wireless signal rate derived from IEEE Standard 802.11 specifications. Actual throughput can . Network conditions and environmental factors, including volume of network traffic, building materials and construction, and network overhead, lower actual data throughput rate can vary.

Technical Specifications

Table 4. WNR612v3 Router specifications

Feature	Description
Data and routing protocols	TCP/IP, RIP-1, RIP-2, DHCP, PPPoE, PPTP, Dynamic DNS, and UPnP.
Power adapter AC plug is localized	<ul style="list-style-type: none"> • 110V-240V, 50/60 Hz, input • All regions (output): 5V DC @ 1A, output
Dimensions	126 x 105 x 30mm (4.96 x 3.7 x 1.2 in)
Weight	0.123 kg (0.27 lb)
Operating temperature	-5° to 45° C (23° to 113° F)
Operating humidity	95% maximum relative humidity, noncondensing
Electromagnetic Emissions	China CCC & SRRC, CE
LAN	10BASE-T or 100BASE-Tx, RJ-45
WAN	10BASE-T or 100BASE-Tx, RJ-45
Wireless	Maximum wireless signal rate complies with the IEEE 802.11 standard. See the footnote for the previous table.

Table 4. WNR612v3 Router specifications (Continued)

Feature	Description
Radio data rates	Auto Rate Sensing
Data encoding standards	IEEE 802.11n version 2.0 IEEE 802.11n, IEEE 802.11g, IEEE 802.11b 2.4 GHz
Maximum computers per wireless network	Limited by the amount of wireless network traffic generated by each node (typically 50–70 nodes).
Operating frequency range	2.412–2.462 GHz (US) 2.412–2.472 GHz (Europe ETSI)
802.11 security	WPA-PSK, WPA2-PSK, and WPA/WPA2

Notification of Compliance



NETGEAR Wireless Routers, Gateways, APs

Regulatory Compliance Information

Note: This section includes user requirements for operating this product in accordance with National laws for usage of radio spectrum and operation of radio devices. Failure of the end-user to comply with the applicable requirements may result in unlawful operation and adverse action against the end-user by the applicable National regulatory authority.

Note: This product's firmware limits operation to only the channels allowed in a particular Region or Country. Therefore, all options described in this user's guide may not be available in your version of the product.

Europe – EU Declaration of Conformity



Marking by the above symbol indicates compliance with the Essential Requirements of the R&TTE Directive of the European Union (1999/5/EC). This equipment meets the following conformance standards:

EN300 328 (2.4Ghz), EN301 489-17 EN60950-1

For complete DoC, visit the NETGEAR EU Declarations of Conformity website at:

http://support.netgear.com/app/answers/detail/a_id/11621

EDOC in Languages of the European Community

Language	Statement
Cesky [Czech]	<i>NETGEAR Inc.</i> tímto prohlašuje, že tento Radiolan je ve shode se základními požadavky a dalšími příslušnými ustanoveními směrnice 1999/5/ES.
Dansk [Danish]	Undertegnede <i>NETGEAR Inc.</i> erklærer herved, at følgende udstyr Radiolan overholder de væsentlige krav og øvrige relevante krav i direktiv 1999/5/EF.
Deutsch [German]	Hiermit erkläre <i>NETGEAR Inc.</i> , dass sich das Gerät Radiolan in Übereinstimmung mit den grundlegenden Anforderungen und den übrigen einschlägigen Bestimmungen der Richtlinie 1999/5/EG befindet.
Eesti [Estonian]	Käesolevaga kinnitab <i>NETGEAR Inc.</i> seadme Radiolan vastavust direktiivi 1999/5/EÜ põhinõuetele ja nimetatud direktiivist tulenevatele teistele asjakohastele sätetele.
English	Hereby, <i>NETGEAR Inc.</i> , declares that this Radiolan is in compliance with the essential requirements and other relevant provisions of Directive 1999/5/EC.

N150 2-Port Wireless Router WNR612v3

Español [Spanish]	Por medio de la presente <i>NETGEAR Inc.</i> declara que el Radiolan cumple con los requisitos esenciales y cualesquiera otras disposiciones aplicables o exigibles de la Directiva 1999/5/CE.
Ελληνική [Greek]	ΜΕ ΤΗΝ ΠΑΡΟΥΣΑ <i>NETGEAR Inc.</i> ΔΗΛΩΝΕΙ ΟΤΙ Radiolan ΣΥΜΜΟΡΦΩΝΕΤΑΙ ΠΡΟΣ ΤΙΣ ΟΥΣΙΩΔΕΙΣ ΑΠΑΙΤΗΣΕΙΣ ΚΑΙ ΤΙΣ ΛΟΙΠΕΣ ΣΧΕΤΙΚΕΣ ΔΙΑΤΑΞΕΙΣ ΤΗΣ ΟΔΗΓΙΑΣ 1999/5/ΕΚ.
Français [French]	Par la présente <i>NETGEAR Inc.</i> déclare que l'appareil Radiolan est conforme aux exigences essentielles et aux autres dispositions pertinentes de la directive 1999/5/CE.
Italiano [Italian]	Con la presente <i>NETGEAR Inc.</i> dichiara che questo Radiolan è conforme ai requisiti essenziali ed alle altre disposizioni pertinenti stabilite dalla direttiva 1999/5/CE.
Latviski [Latvian]	Ar šo <i>NETGEAR Inc.</i> deklarē, ka Radiolan atbilst Direktīvas 1999/5/EK būtiskajām prasībām un citiem ar to saistītajiem noteikumiem.
Lietuvių [Lithuanian]	Šiuo <i>NETGEAR Inc.</i> deklaruoja, kad šis Radiolan atitinka esminius reikalavimus ir kitas 1999/5/EB Direktyvos nuostatas.
Nederlands [Dutch]	Hierbij verklaart <i>NETGEAR Inc.</i> dat het toestel Radiolan in overeenstemming is met de essentiële eisen en de andere relevante bepalingen van richtlijn 1999/5/EG.
Malti [Maltese]	Hawnhekk, <i>NETGEAR Inc.</i> , jiddikjara li dan Radiolan jikkonforma mal-htigijiet essenzjali u ma provvedimenti oħrajn relevanti li hemm fid-Dirrettiva 1999/5/EC.
Magyar [Hungarian]	Alulírott, <i>NETGEAR Inc.</i> nyilatkozom, hogy a Radiolan megfelel a vonatkozó alapvető követelményeknek és az 1999/5/EC irányelv egyéb előírásainak.
Polski [Polish]	Niniejszym <i>NETGEAR Inc.</i> oświadcza, że Radiolan jest zgodny z zasadniczymi wymogami oraz pozostałymi stosownymi postanowieniami Dyrektywy 1999/5/EC.
Português [Portuguese]	<i>NETGEAR Inc.</i> declara que este Radiolan está conforme com os requisitos essenciais e outras disposições da Directiva 1999/5/CE.
Slovensko [Slovenian]	<i>NETGEAR Inc.</i> izjavlja, da je ta Radiolan v skladu z bistvenimi zahtevami in ostalimi relevantnimi določili direktive 1999/5/ES.
Slovensky [Slovak]	<i>NETGEAR Inc.</i> týmto vyhlasuje, že Radiolan spĺňa základné požiadavky a všetky príslušné ustanovenia Smernice 1999/5/ES.
Suomi [Finnish]	<i>NETGEAR Inc.</i> vakuuttaa täten että Radiolan tyyppinen laite on direktiivin 1999/5/EY oleellisten vaatimusten ja sitä koskevien direktiivin muiden ehtojen mukainen.
Svenska [Swedish]	Härmed intygar <i>NETGEAR Inc.</i> att denna Radiolan står i överensstämmelse med de väsentliga egenskapskrav och övriga relevanta bestämmelser som framgår av direktiv 1999/5/EG.

N150 2-Port Wireless Router WNR612v3

Íslenska [Icelandic]	Hér með lýsir <i>NETGEAR Inc.</i> yfir því að Radiolan er í samræmi við grunnkröfur og aðrar kröfur, sem gerðar eru í tilskipun 1999/5/EC.
Norsk [Norwegian]	<i>NETGEAR Inc.</i> erklærer herved at utstyret <i>Radiolan</i> er i samsvar med de grunnleggende krav og øvrige relevante krav i direktiv 1999/5/EF.

This device is a 2.4 GHz wideband transmission system (transceiver), intended for use in all EU member states and EFTA countries, except in France and Italy where restrictive use applies.

In Italy the end-user should apply for a license at the national spectrum authorities in order to obtain authorization to use the device for setting up outdoor radio links and/or for supplying public access to telecommunications and/or network services.

This device may not be used for setting up outdoor radio links in France and in some areas the RF output power may be limited to 10 mW EIRP in the frequency range of 2454 - 2483.5 MHz. For detailed information the end-user should contact the national spectrum authority in France.

FCC Requirements for Operation in the United States

FCC Information to User

This product does not contain any user serviceable components and is to be used with approved antennas only. Any product changes or modifications will invalidate all applicable regulatory certifications and approvals.

FCC Guidelines for Human Exposure

This equipment complies with FCC radiation exposure limits set forth for an uncontrolled environment. This equipment should be installed and operated with minimum distance of 20 cm between the radiator and your body.

This transmitter must not be co-located or operating in conjunction with any other antenna or transmitter.

FCC Declaration of Conformity

We, NETGEAR, Inc., 350 East Plumeria Drive, San Jose, CA 95134, declare under our sole responsibility that the N150 2-Port Wireless Router WNR612v3 complies with Part 15 Subpart B of FCC CFR47 Rules. Operation is subject to the following two conditions:

- This device may not cause harmful interference, and
- This device must accept any interference received, including interference that may cause undesired operation.

FCC Radio Frequency Interference Warnings & Instructions

This equipment has been tested and found to comply with the limits for a Class B digital device, pursuant to Part 15 of the FCC Rules. These limits are designed to provide reasonable protection against harmful interference in a residential installation. This equipment uses and can radiate radio frequency energy and, if not installed and used in accordance with the instructions, may cause harmful interference to radio communications. However, there is no guarantee that interference will not occur in a particular installation. If this equipment does cause harmful interference to radio or television reception, which can be determined by turning the equipment off and on, the user is encouraged to try to correct the interference by one or more of the following methods:

- Reorient or relocate the receiving antenna.
- Increase the separation between the equipment and the receiver.
- Connect the equipment into an electrical outlet on a circuit different from that which the radio receiver is connected.
- Consult the dealer or an experienced radio/TV technician for help.

FCC Caution

- Any changes or modifications not expressly approved by the party responsible for compliance could void the user's authority to operate this equipment.
- This device complies with Part 15 of the FCC Rules. Operation is subject to the following two conditions: (1) This device may not cause harmful interference, and (2) this device must accept any interference received, including interference that may cause undesired operation.

- For product available in the USA market, only channel 1~11 can be operated. Selection of other channels is not possible.
- This device and its antenna(s) must not be co-located or operation in conjunction with any other antenna or transmitter.

Canadian Department of Communications Radio Interference Regulations

This digital apparatus (N150 2-Port Wireless Router WNR612v3) does not exceed the Class B limits for radio-noise emissions from digital apparatus as set out in the Radio Interference Regulations of the Canadian Department of Communications.

This Class [B] digital apparatus complies with Canadian ICES-003.

Cet appareil numérique de la classe [B] est conforme à la norme NMB-003 du Canada

Industry Canada

This device complies with RSS-210 of the Industry Canada Rules. Operation is subject to the following two conditions: (1) This device may not cause harmful interference, and (2) this device must accept any interference received, including interference that may cause undesired operation.

IMPORTANT NOTE: Radiation Exposure Statement:

This equipment complies with IC radiation exposure limits set forth for an uncontrolled environment. This equipment should be installed and operated with minimum distance 20cm between the radiator & your body.

Caution:

Ce dispositif est conforme à la norme CNR-210 d'Industrie Canada applicable aux appareils radio exempts de licence. Son fonctionnement est sujet aux deux conditions suivantes: (1) le dispositif ne doit pas produire de brouillage préjudiciable, et (2) ce dispositif doit accepter tout brouillage reçu, y compris un brouillage susceptible de provoquer un fonctionnement indésirable.

NOTE IMPORTANTE: Déclaration d'exposition aux radiations:

Cet équipement est conforme aux limites d'exposition aux rayonnements IC établies pour un environnement non contrôlé. Cet équipement doit être installé et utilisé avec un minimum de 20 cm de distance entre la source de rayonnement et votre corps.

Interference Reduction Table

The table below shows the Recommended Minimum Distance between NETGEAR equipment and household appliances to reduce interference (in feet and meters).

Household Appliance	Recommended Minimum Distance (in feet and meters)
Microwave ovens	30 feet / 9 meters
Baby Monitor - Analog	20 feet / 6 meters
Baby Monitor - Digital	40 feet / 12 meters
Cordless phone - Analog	20 feet / 6 meters
Cordless phone - Digital	30 feet / 9 meters
Bluetooth devices	20 feet / 6 meters
ZigBee	20 feet / 6 meters

Index

A

- access
 - remote **76**
 - viewing logs **56**
- access control
 - turning on **61**
- access points **62**
- accessing remote computer **65**
- adding
 - custom service **70**
 - priority rules **41**
- address reservation **39**
- advertisement period **77**
- alerts, emailing **49**
- applications, QoS for online gaming **41**
- attached devices **21**
- authentication, required by mail server **49**
- automatic firmware checking **51**
- automatic Internet connection **32**

B

- back panel **9**
- backing up configuration **57**
- base station, setting up **64**
- blocking
 - inbound traffic **65**
 - keywords **45**
 - services **46**
 - sites **45**
- box contents **7**

C

- cables, checking **81**
- changes not saved, router **86**
- compliance **92**
- configuration file **57**
- configuring
 - DMZ server **35**
 - Dynamic DNS **74**
 - NAT **34**
 - port forwarding **69**

- port triggering **71**
 - QoS **40**
 - repeater unit **65**
 - user-defined services **46**
- connecting wirelessly **7**
 - crossover cable **82**
 - CTS/RTS Threshold **60**
 - custom service (port forwarding) **70**

D

- dashboard **15**
- data packets, fragmented **35**
- default DMZ server **35**
- default factory settings, list of **89**
- default factory settings, restoring **58, 87**
- default gateway **54**
- deleting
 - keywords **45**
- denial of service (DoS) protection **44**
- devices, attached **21**
- DHCP server **38, 54**
- DHCP setting **53**
- DMZ server **35**
- DNS addresses
 - troubleshooting **84**
- DNS servers **66**
- Domain Name Server (DNS) addresses **20, 21, 53**
- Dynamic DNS **73**
- DynDNS.org **73**

E

- electromagnetic emissions **90**
- email notices **49**
- encryption keys **28**
- Ethernet cables, checking **81**
- Ethernet LED, troubleshooting and **82**

F

- factory default settings, restoring **58, 87**
- factory settings

- list of **89**
- resetting **10**
- FastLane **29**
- firmware version **52**
- firmware, upgrading **14, 51**
- fragmentation length **60**
- fragmented data packets **35**
- front panel **8**

G

- games, online, QoS for **41**
- gateway IP address **20**
- Genie, NETGEAR **13**
- guest networks **27**

H

- host name **20**
- host, trusted **45**

I

- inbound traffic, allowing or blocking **65**
- installing NETGEAR Genie **13**
- Internet connection
 - setting up **19**
 - troubleshooting **83**
- Internet LED, troubleshooting and **82**
- Internet port **32, 52**
- Internet Relay Chat (IRC) **67**
- Internet service provider (ISP)
 - account information **12**
 - Internet Setup screen **20**
 - login **12**
- Internet services, blocking access **46**
- Internet Setup screen **20**
- interval, poll **53**
- IP addresses
 - current **53**
 - DHCP **12**
 - dynamic **73**
 - reserved **39**
- IP subnet mask **53**

K

- keywords **45**

L

- label, product **10**

- LAN port
 - QoS for **42**
 - settings **52**
- LAN setup **37**
- lease, DHCP **54**
- LEDs
 - described **9**
 - troubleshooting and **82**
- local servers, port forwarding to **69**
- logging in **12, 14**
- logs
 - emailing **49**
 - viewing **56**

M

- MAC addresses
 - current **52**
 - product label **10**
 - QoS for **43**
- mail server, outgoing **49**
- maintenance settings **50**
- managing router remotely **76**
- menus, described **15**
- metric value **75**
- mixed mode security options **28**
- MTU size **35**
- multicasting **38**

N

- NAT (Network Address Translation) **34, 35, 66**
- NETGEAR Genie **13**
- network, how to restart **81**
- networks, guest **27**
- networks, troubleshooting **81**

O

- outgoing mail server **49**

P

- packets, fragmented **35**
- Parental Controls **22**
- passphrases
 - changing **26**
 - product label **10**
- password, restoring **87**
- poll interval **53**
- port filtering **46**
- port forwarding **65, 68, 69**

port numbers **46**
 port status **53**
 port triggering **65, 67, 69, 71**
 ports, listed, back panel **9**
 positioning the router **7**
 Power LED, troubleshooting and **82**
 PPPoE (PPP over Ethernet) **84**
 Preamble mode **60**
 preset security
 about **24**
 passphrase **26**
 pre-shared key **28**
 primary DNS addresses **21**
 prioritizing traffic **40**

Q

QoS (Quality of Service) **40**

R

radio, wireless **60**
 range of wireless connections **7**
 releasing connection status **54**
 remote management **76**
 renewing connection status **54**
 repeater units **65**
 reserved IP addresses **39**
 restarting network **81**
 restoring
 configuration file **57**
 default factory settings **58, 87**
 router interface, described **15**
 router status, viewing **52**

S

scheduling keyword and service blocking **48**
 secondary DNS **21**
 security **24**
 firewall settings **44**
 see also security options
 security options **28**
 security PIN **10, 33**
 sending logs by email **49**
 serial number, product label **10**
 services, blocking **46**
 settings, default. See default factory settings
 Setup Wizard **32**
 sites, blocking **45**
 SMTP server **49**

specifications, technical **89**
 SSID, described **26**
 static routes **74**
 status, router, viewing **52**
 subnet mask **53**
 system up time **53**

T

technical specifications **89**
 technical support **2**
 Temporal Key Integrity Protocol (TKIP) **28**
 time to live, advertisement **77**
 time-out, port triggering **72**
 trademarks **2**
 traffic metering **78**
 troubleshooting **80**
 log in access **83**
 router changes not saved **86**
 trusted host **45**

U

Universal Plug and Play (UPnP) **77**
 up time, system **53**
 upgrading firmware **14, 51**
 user-defined services **46**

V

viewing
 logs **56**
 router status **52**

W

WAN IP address, troubleshooting **84**
 WAN setup **33**
 Wi-Fi Protected Setup (WPS) **32**
 Wireless Card Access List **61**
 wireless channel **26**
 wireless connection, troubleshooting **86**
 wireless connections **7**
 wireless devices, adding to the network **16**
 Wireless Distribution System (WDS) **62, 63**
 Wireless LED, troubleshooting and **83**
 wireless mode **26**
 wireless network name (SSID)
 broadcast **25**
 described **26**
 product label **10**

- wireless network settings **26**
- wireless radio **60**
- wireless repeating **62, 63**
 - base station **64**
 - repeater unit **65**
- wireless security options **28**
- wireless settings **24**
 - checking for correct **81**
 - SSID broadcast **25**
- WMM (Wi-Fi Multimedia) **40**
- WPA encryption **28**
- WPA2 encryption **28**
- WPA2-PSK encryption **28**
- WPA-PSK/WPA2-PSK mixed mode **28**
- WPS-PSK encryption **28**
- WPS-PSK+ WPA2-PSK encryption **28**